

# Focus Premium Laser Scanner User Manual



# Legal Notices

## Release Notice

This is the March 2022 version of the Focus Premium Laser Scanner User Manual. It applies to the FARO Focus Premium Scanner. FARO® Technologies Inc., March 2022. All rights reserved.

No part of this publication may be reproduced, or transmitted in any form or by any means without written permission of FARO Technologies, Inc.

FARO TECHNOLOGIES, INC. MAKES NO WARRANTY, EITHER EXPRESS OR IMPLIED, INCLUDING BUT NOT LIMITED TO ANY IMPLIED WARRANTIES OF MERCHANTABILITY OR FITNESS FOR A PARTICULAR PURPOSE, REGARDING THE FARO LASER SCANNER, FARO SCANPLAN, FARO FREESTYLE 2 AND ANY MATERIALS, AND MAKES SUCH MATERIALS AVAILABLE SOLELY ON AN “AS-IS” BASIS.

IN NO EVENT SHALL FARO TECHNOLOGIES INC. BE LIABLE TO ANYONE FOR SPECIAL, COLLATERAL, INCIDENTAL, OR CONSEQUENTIAL DAMAGES IN CONNECTION WITH OR ARISING OUT OF THE PURCHASE OR USE OF THE FARO LASER SCANNER, FARO SCANPLAN, FARO FREESTYLE 2 OR THEIR MATERIALS. THE SOLE AND EXCLUSIVE LIABILITY TO FARO TECHNOLOGIES, INC., REGARDLESS OF THE FORM OF ACTION, SHALL NOT EXCEED THE PURCHASE PRICE OF THE MATERIALS DESCRIBED HEREIN.

THE INFORMATION CONTAINED IN THIS MANUAL IS SUBJECT TO CHANGE WITHOUT NOTICE AND DOES NOT REPRESENT A COMMITMENT ON THE PART OF FARO TECHNOLOGIES INC. ACCEPTANCE OF THIS DOCUMENT BY THE CUSTOMER CONSTITUTES ACKNOWLEDGMENT THAT IF ANY INCONSISTENCY EXISTS BETWEEN THE ENGLISH AND NON-ENGLISH VERSIONS, THE ENGLISH VERSION TAKES PRECEDENCE.

## Copyright Notice

© Copyright 2022 FARO Technologies Inc..

This product includes third-party and open source resources. For license and copyright information pertaining to the use of these resources, refer to the following document in the FARO Knowledge Base: [https://knowledge.faro.com/Essentials/General/3rd-Party\\_Open\\_Source\\_License\\_Information\\_for\\_FARO\\_Products](https://knowledge.faro.com/Essentials/General/3rd-Party_Open_Source_License_Information_for_FARO_Products)

# Table of Contents

<b>Legal Notices</b> .....	<b>i</b>
Copyright Notice .....	i
<b>Chapter 1: General Information</b> .....	<b>1</b>
Notes and Signs .....	1
<b>Chapter 2: Introduction</b> .....	<b>2</b>
Focus Premium Features .....	3
FARO Stream .....	5
FARO Sphere .....	5
Equipment .....	6
Required additional equipment .....	6
Recommended additional equipment .....	7
<b>Chapter 3: Safety Precautions</b> .....	<b>8</b>
Intended Use .....	8
Improper Use .....	8
Operators .....	8
General Safety Information .....	8
Nameplate symbols .....	9
Laser Safety .....	10
Electrical Safety .....	10
Power Block Battery Safety Measures .....	11
Power Dock Battery Charger Safety Measures .....	11
Mechanical Safety .....	12
Transport .....	13
Storage .....	14
Servicing .....	14
<b>Chapter 4: Parts and Their Functions</b> .....	<b>15</b>

Display Side .....	15
Battery Side .....	16
Front Side .....	17
Bottom Side .....	18
Power Dock Battery Charger .....	19
LED Behavior when Battery Charger is Connected to Power Dock or Scanner .....	19
Maintenance of Power Dock Battery Charger .....	20
Status Indicator .....	20
Inserting the status indicator .....	21
Removing the status indicator .....	22
<b>Chapter 5: Getting Started .....</b>	<b>23</b>
Charging the Battery .....	23
Charging the Battery in the FARO Focus Premium .....	23
Charging the Battery with the Power Dock Battery Charger .....	25
Tips for Using the Battery .....	28
Setting up the FARO Focus Premium .....	29
Setting up the Tripod .....	29
Inverting the scanner .....	31
Mounting and Using the Quick Release .....	32
Prepare the Tripod .....	32
Prepare the Scanner .....	32
SD Card .....	33
Preparing an SD Card .....	33
Structure of the SD Card .....	34
Inserting the SD Card .....	35
Switching on the FARO Focus Premium .....	36
Initial Scanner Settings .....	36
Setting the Interface Language .....	37
Setting the Date and Time .....	37
Setting the Unit of Length and the Temperature Scale .....	38
Scanner Details .....	39
Scanning .....	39
FARO Stream .....	40
Setting the Scanning Parameters .....	40
Starting a Scan .....	49
Strong Scanner Inclination .....	51

LED Behavior .....	52
Data Security .....	52
Shutting Down the FARO Focus Premium .....	53
Powering Off the FARO Focus Premium .....	53
<b>Chapter 6: Controller Software .....</b>	<b>54</b>
General Elements .....	54
Status Bar .....	54
Scanner Menu Map .....	57
Parameters .....	57
Scans .....	58
Manage .....	58
Navigation Bar .....	63
Frequently Used Buttons .....	63
Home Screen .....	64
Scan Parameters .....	66
Selected Profile .....	67
Resolution / Quality .....	68
Horizontal and Vertical Scan Range .....	69
Select Sensors .....	69
Scan with Color .....	70
Manage .....	70
Scan Projects and Clusters .....	71
Description of Project Button Icons .....	76
Selected Profile .....	76
Description of Factory Profiles .....	77
Operators .....	78
Sensors .....	80
Level the Scanner Using Inclinometer .....	81
General Settings .....	86
Status .....	90
WLAN Mode Scanner Settings .....	90
Access Point Mode Settings .....	93
Example Configuration of a Notebook with Microsoft Windows .....	93
Notebooks in Ad Hoc Mode .....	94
Remotely Accessing Scans on the SSD or SD Card .....	95
Scanner Details .....	96
On-Site Registration .....	97

Service .....	98
Online Updates .....	100
Update via SD Card .....	101
Storage Management .....	101
View Scans .....	102
Online Help and Notifications .....	103
Notifications .....	103
Help .....	103
<b>Chapter 7: Special Scanning Modes .....</b>	<b>105</b>
Scanner Control .....	106
On-Site Registration .....	107
On-Site Registration Setup .....	108
Map Page .....	110
List Page .....	112
Scan Details Page .....	113
On-Site Compensation .....	114
Choose the Compensation Site .....	114
On-Site Compensation Best Practices .....	115
Connect Laser Scanner to your Smart Device through Wireless LAN .....	115
Using the Scanner as a WLAN Access Point .....	115
On-Site Compensation in FARO Stream App .....	116
Troubleshooting .....	116
Scan Groups .....	116
Creating a Scan Group .....	117
Retaking Pictures .....	119
<b>Chapter 8: Maintenance .....</b>	<b>120</b>
Cleaning Instructions for Optics .....	120
What Is Needed .....	121
Cleaning Slightly Contaminated Optics .....	122
Dry Pre-Cleaning (Non-Contact Cleaning) .....	122
Wet Cleaning with Tissue and Isopropyl Alcohol as a Cleaning Fluid .....	123
Cleaning of Strongly Contaminated Optics .....	127
Dry Pre-Cleaning (Non-Contact Cleaning) .....	128
Wet Cleaning with Water or Diluted Mild Soap Solution .....	128
<b>Chapter 9: Technical Data .....</b>	<b>131</b>

General .....	131
Ports .....	131
Laser (Optical Transmitter) .....	132
Data Handling and Control .....	132
Ranging Unit .....	132
Color Unit .....	133
Multi-Sensor .....	133
Interface Connection .....	134
Deflection Unit .....	134
Ambient Conditions .....	134
Scanner Dimensions .....	135
Scanner Mount Dimensions .....	136
<b>Chapter 10: Error Messages .....</b>	<b>137</b>
<b>Chapter 11: Disposal .....</b>	<b>139</b>
<b>Chapter 12: Technical Support .....</b>	<b>140</b>
<b>Appendix A: Software License Agreement .....</b>	<b>142</b>
<b>Appendix B: Purchase Conditions .....</b>	<b>144</b>
<b>Appendix C: Industrial Service Policy .....</b>	<b>150</b>
<b>Appendix D: Industrial Products Service Policy .....</b>	<b>153</b>
<b>Appendix E: Certifications .....</b>	<b>154</b>
Certifications .....	154
CE Declaration of Conformity .....	154
RF exposure statement .....	154
FCC Notices .....	155
FCC Equipment Authorization .....	155
Industry Canada (IC): .....	155

# Chapter 1: General Information

## Notes and Signs

---

**DANGER:** A DANGER denotes a hazard. It calls attention to an operating procedure or practice that, if not correctly performed or adhered to, will result in personal injury or death. Do not proceed beyond a DANGER notice until the indicated conditions are fully understood and met.

---

---

**WARNING:** A WARNING denotes a hazard. It calls attention to an operating procedure or practice that, if not correctly performed or adhered to, could result in personal injury or death. Do not proceed beyond a WARNING notice until the indicated conditions are fully understood and met.

---

---

**CAUTION:** CAUTION denotes a hazard. It calls attention to an operating procedure or practice that, if not correctly performed or adhered to, could result in personal injury. Do not proceed beyond a CAUTION notice until the indicated conditions are fully understood and met.

---

---

**NOTICE:** A NOTICE denotes a hazard. It calls attention to an operating procedure or practice that, if not correctly performed or adhered to, could result in damage to the product or loss of important data. Do not proceed beyond a NOTICE notice until the indicated conditions are fully understood and met.

---

---

**NOTE:** A NOTE is additional information that aids you in the use or understanding of the equipment or subject. They are not used when a WARNING or CAUTION is applicable. They are not safety related and may be placed either before or after the associated text.

---

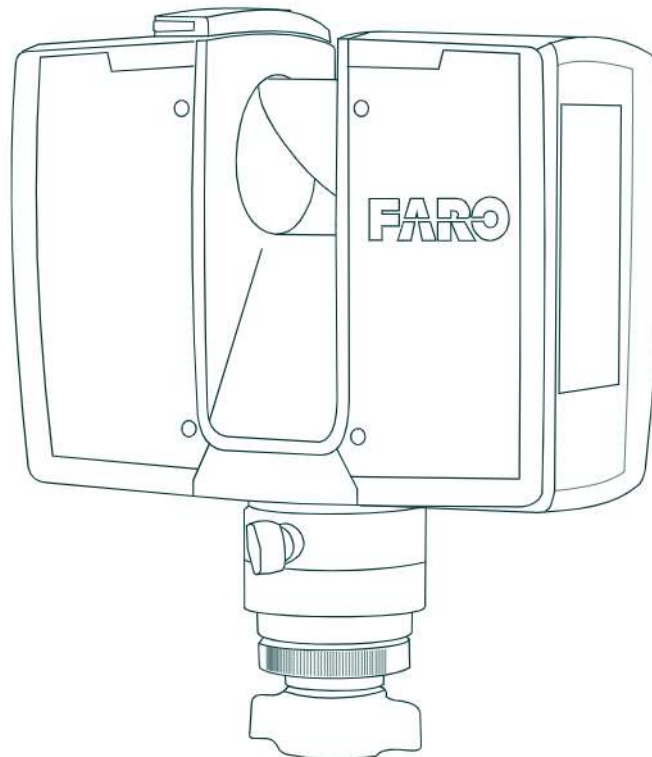


## Chapter 2: Introduction

The FARO Focus Premium is a high-speed three-dimensional laser scanner for detailed measurement and documentation. The FARO Focus Premium uses laser technology to produce very detailed three-dimensional images of complex environments and geometries in minutes. The resulting images consist of millions of 3D measurement points.

The scanner is designed to scan objects at distances between 0.5 meters and approximately 70, 150, or 350 meters, depending on your license. Additional features, such as Swift, are also available with extra licenses. Contact your FARO Sales representative for information.

Focus Premium provides exceptional capturing efficiency, data quality and accuracy for professional applications across the construction, public safety, operations and maintenance and manufacturing markets.



*Figure 2-1 FARO Focus Premium*

## Focus Premium Features

- A scanning range of up to 350 meters, providing superior area coverage per scan position.
- Intuitive control through the built-in touchscreen display and phone-enabled remote control capabilities by WLAN for seamless connectivity with FARO Stream app and FARO Sphere cloud-based collaboration platform.
- On-site registration for faster project completion and real-time awareness of scan errors or missing data with the Stream app.
- HYPERMODULATION™
- High accuracy, high resolution, high speed laser scanning
- Easy mobility, due to its compact size, lightness, and the integrated quick-charge battery.
- High Dynamic Range (HDR) imaging method merges images captured with different exposure settings into one image with a greater dynamic range of luminosity.
- Photo-realistic 3D color scans, due to the integrated color camera or panorama camera.
- Integrated dual-axis compensator to automatically level the captured scan data.
- Integrated GPS sensor to determine the scanner position.
- Integrated compass and altimeter to give the scans orientation and height information.
- Integrated high-speed SSD data storage for maximum scan capacity and lightning fast scan processing.
- Rugged construction and housing that can withstand tough, day-to-day work.

The FARO Focus Premium works by sending an infrared laser beam ① into the center of a rotating mirror ②. The mirror deflects the laser beam on a vertical rotation around the environment being scanned; scattered light from surrounding objects is then reflected back into the scanner.

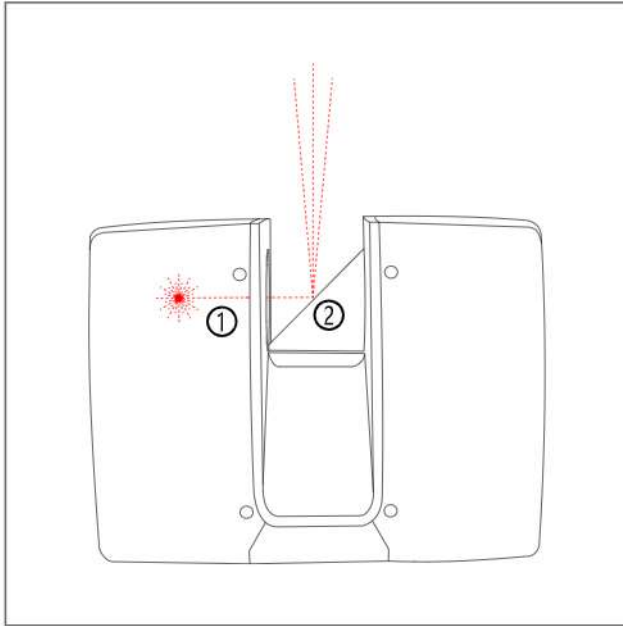


Figure 2-2 Laser Deflection

For distance measuring, the FARO Focus Premium uses phase-shift technology. This means that constant waves of infrared light of varying length are projected outward from the scanner. Upon contact with an object, the light is reflected back to the scanner. The distance from the scanner to the object is accurately determined by measuring the phase shifts in the waves of the infrared light. HYPERMODULATION™ greatly enhances the signal-to-noise ratio of the modulated signal with the help of a special modulation technology. The x, y, z coordinates of each point are then calculated by using angle encoders, which measure the mirror rotation and the horizontal rotation of the FARO Focus Premium. These angles are encoded simultaneously with the distance measurement. The scanner covers a 360° x 300° field of view.

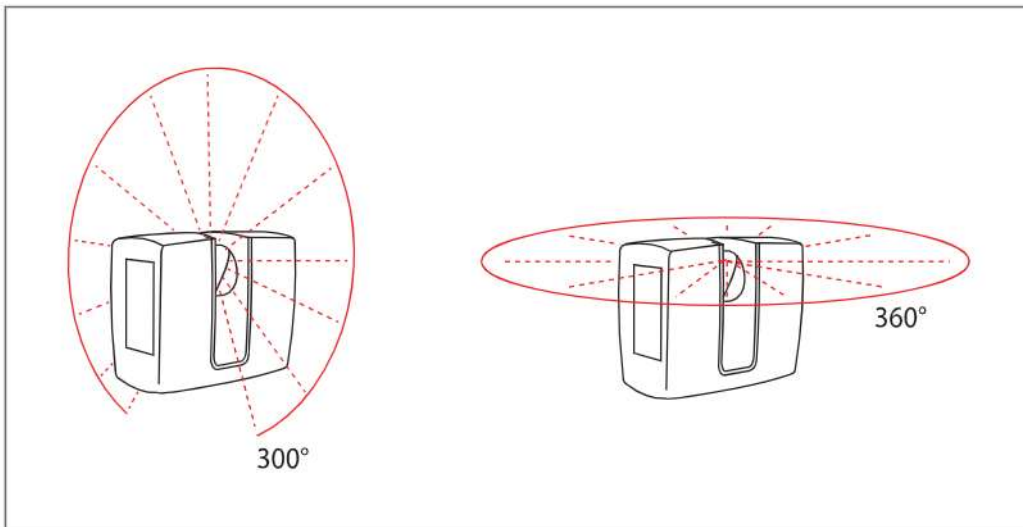


Figure 2-3 Vertical and Horizontal Rotation

Additionally, the FARO Focus Premium determines the reflectivity of the captured surfaces by measuring the intensity of the received laser beam. Generally, bright surfaces reflect a greater portion of the emitted light than dark surfaces. This reflectivity is used to assign a corresponding value to each point.

The single point-measurements are repeated up to 2 million times per second. The result is a point cloud; a three-dimensional data set of the scanner's environment (hereafter referred to as the laser scan, or simply scan). Depending on the selected resolution (points acquired per rotation), each point cloud consists of millions of scan points.

The laser scans are recorded on a high speed SSD and can be exported via removable SD card, enabling easy and secure transfer to SCENE, FARO's point cloud editing software, or on the FARO Sphere cloud solution.

This manual provides an introduction to the FARO Focus Premium. Read the safety information in chapter *Safety Precautions* on page 8 and the step-by-step guide in chapter *Getting Started* on page 23 before using the FARO Focus Premium.

The scanner also has on-screen help that can be accessed during operation by tapping the Help button on the screen. *For more information, see Online Help and Notifications.*

A list of the potential fields of application of the FARO Focus Premium can be found on the FARO web page [www.faro.com](http://www.faro.com).

## FARO Stream

Stream is a mobile app that connects FARO hardware with FARO Sphere cloud-based applications and services. By uniting hardware with cloud software, Stream makes on-site capture workflows more efficient and brings captured data directly into the FARO ecosystem. It does so by providing live feedback of the captured scans while performing its pre-registration function.

Stream provides the best on-site efficiency for data capture with the Focus Premium scanner for scan operations in architecture, engineering, construction and facility management. Users can be confident in the successful and complete scan data they collect in real-time, confident that no additional site visits will be required because of missing data and confident in radically expedited project finalization times as Stream and Sphere are already doing some of the work automatically while a Focus Premium operator is returning from the field. The Focus Premium also allows the ability to include complementary data like field annotations and photographic images to the project after a scan is complete.

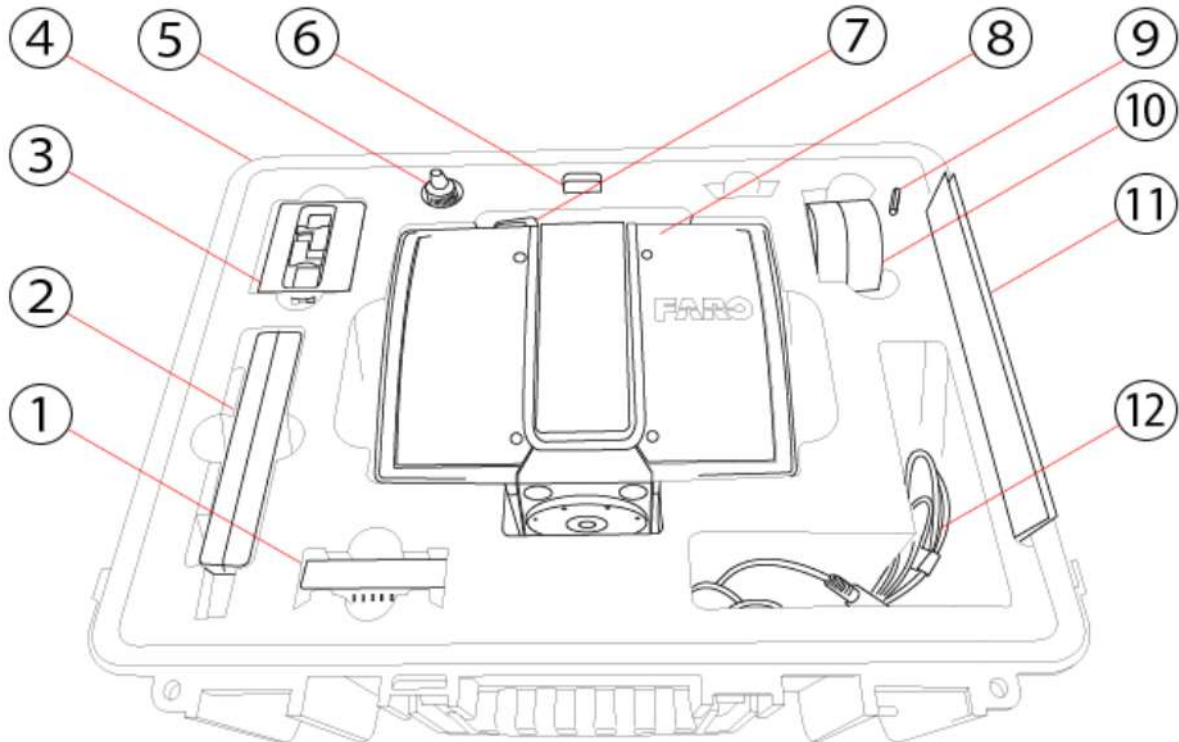
## FARO Sphere

Sphere is a cloud application that provides users with a centralized, efficient, and collaborative environment across FARO point cloud applications and customer support tools for faster 3D data capture, processing, and delivery through a secure, single point sign-on process. With Stream and Sphere, registration starts in the field and processing is performed in the cloud while the scan operator is driving back to the office. This allows off-site colleagues to already work on the data or share it with end-customers via FARO WebShare Software, the world's leading collaborative point cloud project management solution.

Additionally, Sphere leverages WebShare to integrate three customer service platforms: Knowledge Base, which provides technical product information, FARO Support, which provides 24-7 personalized service, and FARO Academy, which provides on-demand and live training and education programs.

## Equipment

The FARO Focus Premium is shipped with the following standard equipment:



- |   |                                       |
|---|---------------------------------------|
| ① Power Dock battery charger                                      | ⑦ Status indicator                    |
| ② Power supply unit   | ⑧ Laser scanner                       |
| ③ Power Block battery (ACCS-PWR-0014)                             | ⑨ 4 mm hex key                        |
| ④ Scanner transport and carrying case                             | ⑩ Quick Release                       |
| ⑤ Mirror cleaning liquid for optics                               | ⑪ Quick Start Guide and Safety Manual |
| ⑥ SD card reader (An SD card is already inserted in the scanner.) | ⑫ AC power cable                      |

## Required additional equipment

FARO-recommended tripod (FAROorder number ACCSS8032)

## Recommended additional equipment

- Spare battery
- Thermal cover
- PanoCam

---

**NOTE:** The charged Power Block battery and a tripod are the minimum required equipment for carrying out a scanning project.

---

## Chapter 3: Safety Precautions

Read this user manual carefully and completely. Refer to it before using the product. Pay careful attention to all warnings, and follow the instructions step-by-step.

### Intended Use

Use the product under the operating conditions and limitations described in this user manual.

### Improper Use

Improper use means using the product other than described in this user manual, or under operating conditions that differ from those described herein.

Improper use of the product can impair the protection provided by the product, and product damage or serious personal injury can occur.

### Operators

In the interests of safety, the laser scanner and its accessories should only be used by suitably-trained and knowledgeable operators, after they have read and understood this manual, and carefully considered all potential hazards involved.

We recommend that operators participate in trainings offered by FARO.

### General Safety Information

- Do not open the housing. Opening the housing can result in serious personal injury due to dangerously high voltages, or damage to the product, which will affect the product's warranty.
- Do not use parts not supplied or recommended by FARO.

- Only replacement parts authorized by FARO may be used, and in accordance with the instructions provided by FARO.
- Do not expose the FARO Focus Premium and its accessories to **extreme temperatures**. The ambient temperature must not be lower or higher than given in the specifications. Do not use the FARO Focus Premium near heat sources, such as radiators, heat registers, or other heat-producing products (including amplifiers).
- Do not **immerse** the FARO Focus Premium and its accessories in **water**. Liquid inside the product enclosure can lead to damage, fire, or electric shocks.
- Properly dispose of the product and batteries in accordance to the local and national regulations. For more information, see [Disposal on page 139](#).
- Do not use the FARO Focus Premium and its accessories in an **explosive environment**. Do not operate the instrument in the presence of flammable gases or fumes. Operation of any electrical instrument in such an environment constitutes a safety hazard.
- Do not use the FARO Focus Premium in the vicinity of strong **magnetic or electrical fields**.
- Before operating the FARO Focus Premium and its accessories in **hazardous areas**, contact the local safety authorities and safety experts.
- For **outdoor use**, use the Power Block battery as the power supply, ensuring that the device is protected from rain or spray water. Use the scanner in a non-condensing environment.
- When the product is transferred from a cold to a significantly-warmer environment, water may condense on some elements inside the scanner. To avoid this, place the scanner in an airtight plastic bag before transfer. This allows the condensation to form on the bag rather than inside the scanner. If you cannot pack the scanner in an airtight manner, wait until observable **condensation water** evaporates from the scanner before switching the FARO Focus Premium on.
- If the scanner becomes wet, let it dry completely before placing it in the transport case. Ensure that the foam in the case never gets wet while unpacking or packing the scanner.

---

**DANGER:** Do not operate the scanner while the external power supply is plugged in. The power cable might damage the turning scanner.

---

## Nameplate symbols



Indicates conformity with health, safety, and environmental protection standards for products sold within the European Economic Area.



Indicates that the product should not be discarded as unsorted waste but must be sent to separate collection facilities for recovery and recycling.





Indicates that the battery should be recycled in an environmentally suitable way.



Indicates that the battery should neither be incinerated nor set on fire.



Indicates that documentation is provided and required to use the product.



Indicates that there are no user serviceable parts inside the housing.



The nameplate on your FARO device may contain this symbol. It indicates that FARO has provided important information in the user manual regarding intended use and safety. Read this information before using the device.



Indicates that the product contains components with the Recognized Component Mark, which is a type of quality mark issued by Underwriters Laboratories (UL).



Indicates that the device is for indoor use only.

## Laser Safety

- The FARO Focus Premium Laser Scanner is classified as a **CLASS 1 LASER PRODUCT** in accordance with IEC 60825-1:2014 (ed. 3).
- Complies with 21 CFR 1040.10 and 1040.11 except for conformance with IEC 60825-1 Ed. 3., as described in Laser Notice No. 56, dated May 8, 2019.
- The FARO Focus Premium Laser Scanner is safe under reasonably foreseeable conditions of operation. The maximum permissible exposure (MPE) cannot be exceeded. It is harmless to the eyes if it is used and maintained in accordance with the instructions in this user manual.

## Electrical Safety

---

**WARNING: Do not open the housing.** Dangerously high voltages are present inside the enclosure. Only qualified service personnel should open the housing. Never push objects of any kind into this product through openings, as they may touch dangerous voltage points or cause short circuits. This could result in a fire, electric shock, or damage to the product.

---

---

**NOTICE:** This device is not intended for use in residential environments, and it cannot ensure a suitable degree of protection of radio reception in such environments.

---

- This product should be operated only from the power source or a battery supplied or recommended by FARO. Ensure that the specifications of the AC converter are met. If you do not know the power-line

voltage in your area, consult your local power company.

- To avoid electrical shock, use the power-supply unit in dry indoor environments only.

## Power Block Battery Safety Measures

These safety measures must be followed, when working with the Power Block battery:

- Only use the charger recommended by FARO to charge the battery.
- Do not charge or discharge damaged batteries.
- Do not charge the battery in the laser scanner while it is stored in the transport case.
- Do not use wet or dirty batteries in the FARO Focus Premium or with the charger.
- Charge between 0 °C and +45 °C (+32 °F and +113 °F) environmental temperature. Recommended charging temperatures: +10 °C to +30 °C (50 °F to +86 °F).
- Discharge between -10 °C and +55 °C (14 °F and +131 °F) environmental temperature. Recommended operating temperatures: +5 °C to +40 °C (+41 °F to +104 °F).
- Insert or remove batteries from the laser scanner in dry, dust-free environments only.
- When the FARO Focus Premium is not in use for long periods of time, remove the battery.
- Store the battery only when it is charged at about 30% of a full charge. We recommend charging the battery to 30% once a year while it is in long-term storage.
- Storage temperatures when at 30% charge are:
  - 1 month: -20 °C to 60 °C (14 °F to 140 °F)
  - 3 months: -20 °C to 45 °C (14 °F to 113 °F)
  - 1 year: -20 °C to 25 °C (14 °F to 77 °F)
- Storage humidity range is 0% to 80%. Store in a well-ventilated area. Do not store with metal objects. A short circuit can cause a fire.
- Do not bring metal objects into contact with the batteries' terminals. The terminals may short-circuit and generate heat.
- Do not immerse batteries into water or fire (danger of explosion).
- Dispose of batteries in accordance with environmental regulations. Contact your local waste disposal management authority for guidelines concerning lithium-ion batteries.

## Power Dock Battery Charger Safety Measures

These safety measures must be followed, when working with the FARO Power Dock battery charger:

- Do not charge any batteries other than the FARO Power Block batteries in the FARO Power Dock charger.
- Regularly check the plug, cord, and charger. In case of damage, contact the FARO Customer Service.
- Do not bring metal objects or fluids into contact with the charger terminals. The terminals may short circuit and generate heat.
- To avoid electrical shock, use the charger and the power supply unit in dry indoor environments only.
- The charger should be kept in a dry room, out of the reach of children and pets.

---

**NOTICE:** Do not leave the battery in the Power Dock when it is not being charged, as this can result in a deep discharge state from which the battery cannot be recharged.

---

---

**DANGER:** Do not operate the charger in an environment allowing exposure to moisture, combustible fluids, or gases. There is a danger of explosion.

---

## Mechanical Safety

---

**WARNING: Rotating Mirror** The mirror unit rotates with high speed while scanning and for a short period after the scan. While the mirror is rotating keep your distance from the product and do not touch the rotating mirror unit with your hands, fingers, hair, clothing or any objects at the risk of personal injury and damage to the FARO Focus Premium.

---

---

**CAUTION: General Use** The FARO Focus Premium may only be used when set on a flat and stable surface. Injuries and serious damage to the device may result if the FARO Focus Premium overturns. Never try to grab the scanner if the tripod tips—grab the tripod instead. Only use equipment recommended by FARO, and follow the FARO setup instructions or the equipment manufacturer's instructions.

---

---

**CAUTION: Do Not Open the Housing** Opening the housing can cause serious personal injury and damage to the product.

---

---

**NOTICE: Cart Usage** If using a cart or tripod dolly, move the setup with special care. Never move the cart by pulling the power cables. Pushing or pulling the cart with too much force, sudden stops, or on an uneven surface can cause disturbances of the FARO Focus Premium's normal functioning.

---

---

**NOTICE: Rotating Scanner** The FARO Focus Premium rotates clockwise up to 360° when performing a scan. Ensure that the FARO Focus Premium's scanner head can rotate freely and will not hit any objects during the scan.

---

---

**NOTICE: Replacement Parts** Use only replacement parts authorized by FARO according to the instructions obtained from FARO. Do not use parts not supplied or recommended by FARO.

---

## Transport

The following precautions must be taken when transporting the laser scanner equipment:

- The laser scanner must be transported in a transport case.
- The laser scanner must be turned off during transportation or shipping.
- Remove the battery from the laser scanner before shipping.
- When carrying the laser scanner, be careful not to drop it. Strong impact can seriously damage the laser scanner, and render it incapable of proper operation.
- Carry the laser scanner separately from its equipment or, for optimal protection, use the original transport case.
- When shipping and transporting the laser scanner by rail, sea, air, or road, use its original transport case and a suitable outer cardboard box for optimal protection against shock and vibration.
- The FARO batteries are lithium-ion batteries and are thus classified as dangerous goods. When transporting or shipping the FARO batteries, ensure that you observe all applicable local and international rules and regulations. For further information, contact your local carrier before transportation or shipping.
- For lithium-ion batteries with less than 100 Wh energy content, an exemption is provided that allows you to carry such a battery without further paperwork. The maximum battery energy a single person can carry is 200 Wh.

Ensure that the total energy content of all batteries that any individual person carries is less than 200 Wh, and that no single battery has more than 100 Wh energy content. Review currently applicable

national and international regulations for transport of Li-On batteries and also verify with you airline or freight company in advance.

## Storage

Prior to storing the laser scanner for prolonged periods:

1. Remove the battery.
2. Pack the scanner and the battery in its shipping case to protect it from environmental hazards, dust, and dirt.
3. Store all components in an environment where:
  - The humidity level is low
  - The temperature is relatively stable
  - The components are not be subjected to extreme temperatures, environmental conditions, or heavy vibrations

## Servicing

Servicing and repair must only be done by qualified service personnel authorized by FARO. Unplug the product from the power outlet and remove the battery. Request servicing, then deliver it to qualified service personnel under the following conditions, if:

- the power-supply cord or plug is damaged.
- the product has been exposed to rain, water, or other liquids.
- the product has been dropped or damaged in any way.
- objects have fallen onto the product.
- the product does not operate normally when following the operating instructions.
- the product exhibits a distinct change in performance.
- the required service and calibration date is reached.

## Chapter 4: Parts and Their Functions

### Display Side

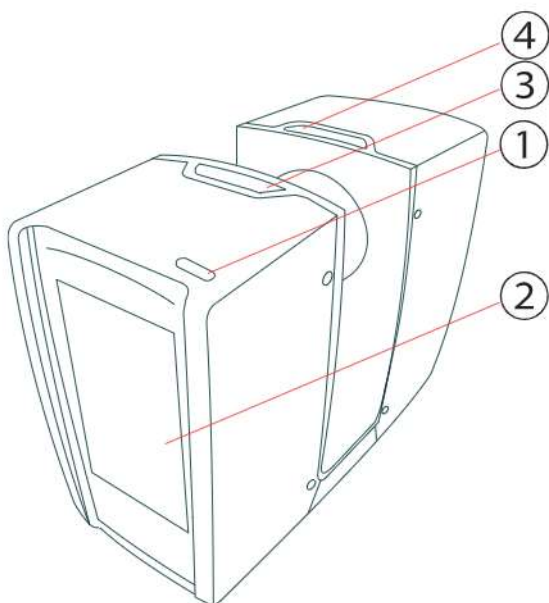


Figure 4-1 Display side of the FARO Focus Premium

- ① **Power On/Off button** - Press for a few seconds (until the LED blinks) to turn on the FARO Focus Premium. If the scanner is on and running, press again to turn it off. You must confirm shutoff by tapping on the display.

---

**NOTE:** In exceptional cases, such as if the shut-down mechanism does not work or the scanner is non-responsive, press and hold the button until the scanner shuts down.

---

- ② **Touchscreen display**
- ③ **Accessory bay 1**
- ④ **Accessory bay 2**

---

**NOTE:** Ensure that the contacts in the accessory bay are clean before using. If not, clean with a cotton swab soaked in isopropyl alcohol.

---

## Battery Side

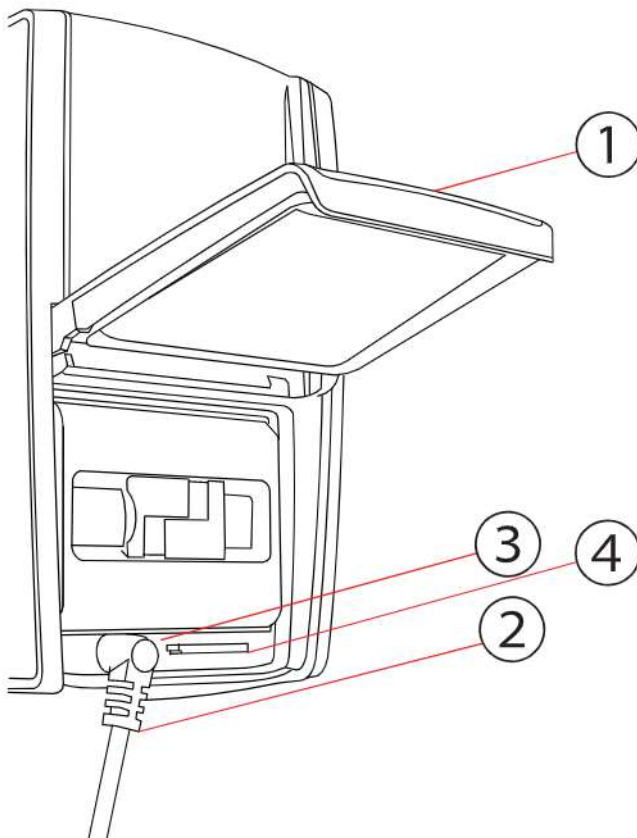


Figure 4-2 Battery Side of the FARO Focus Premium

- ① Battery compartment cover
- ② Socket to plug in the external power supply (ACCS-PWR-0010)
- ③ LED showing battery status
- ④ SD card slot

## Front Side

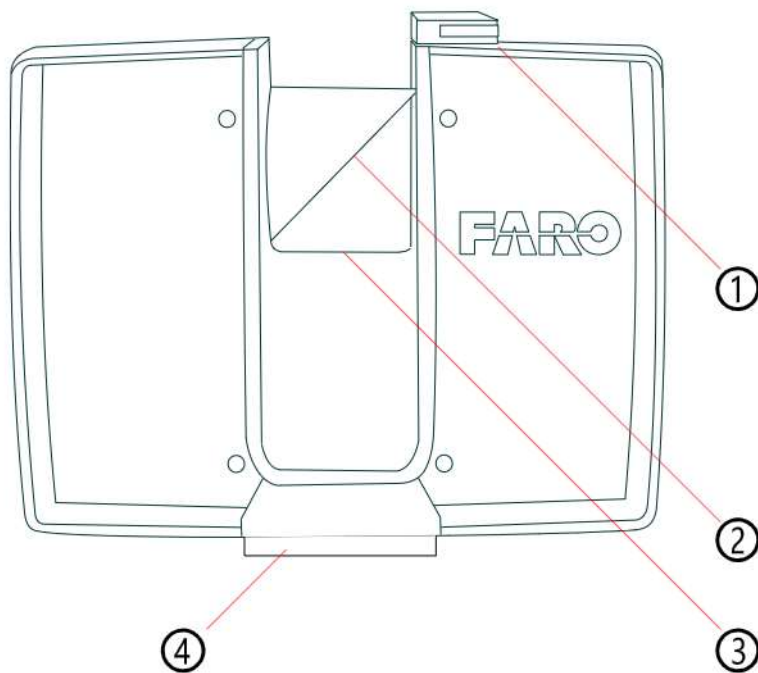


Figure 4-3 Front View of the FARO Focus Premium

- ① **Status Indicator**
- ② **Scanner mirror** - For safety and cleaning instructions, see [Mechanical Safety on page 12](#) and [Cleaning Instructions for Optics on page 120](#).
- ③ **Reference area** - Used for self-referencing the distance measurements while scanning. Keep this area clean and do not peel of the sticker.
- ④ **Scanner mount**



## Bottom Side

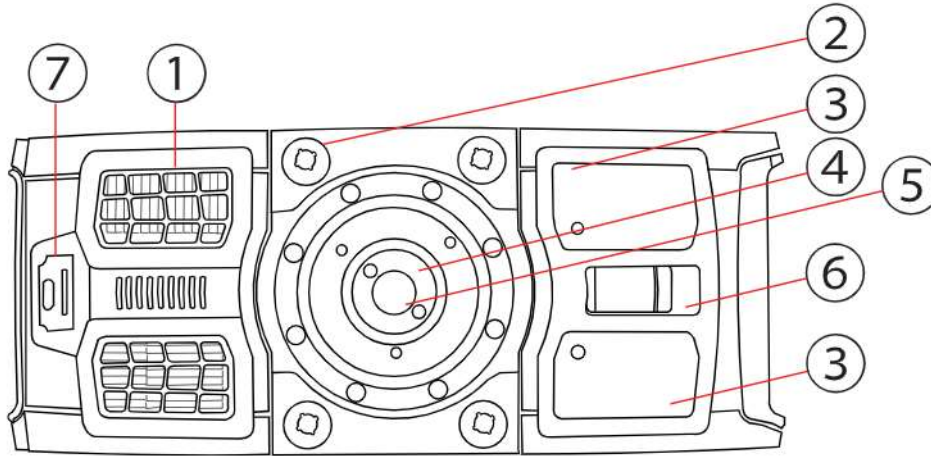


Figure 4-4 Bottom View of the FARO Focus Premium

- ① **Cooling fan openings** - Keep these openings uncovered and at least 18 cm (7 in) from the floor or any other surface.
  - ② **M5 screw threads** - To mount the scanner to customer-specific fixtures.
  - ③ **Type label**
  - ④ **Automation Interface**
- 
- NOTE:** The scanner base interface is not available on all scanner models.
- 
- ⑤ **3/8" screw thread** - To mount the scanner to standard photo tripods.
  - ⑥ **Battery compartment cover release mechanism**
  - ⑦ **USB-C port / service & maintenance port (cover not shown)**

---

**NOTICE:** Do not plug any type of charger into this connector. Only USB slave devices may be attached.

---

## Power Dock Battery Charger

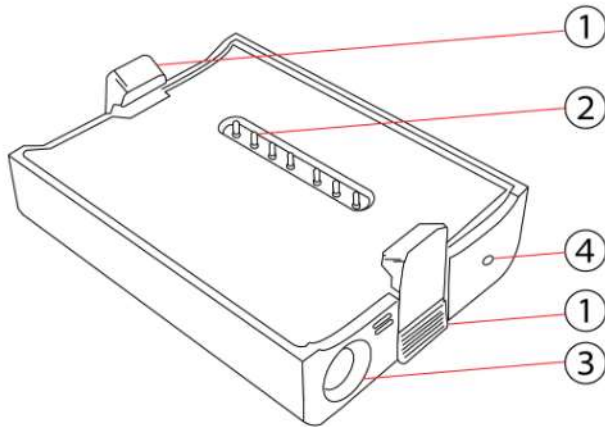


Figure 4-5 Power Dock Battery Charger

- ① **Safety latches** - To insert the battery, push downwards. Push bottom area to open.
- ② **Connectors**
- ③ **Power socket**
- ④ **Power LED** - for LED specifications, see below.

### Power Dock Battery Charger Technical Data:

Rating voltage:	19 V $\overline{=}$
Maximum power:	75 W
Operating temperature:	0 °C to +40 °C (+32 °F to +104 °F)
Humidity:	Non-condensing
Environment:	indoor (pollution degree 2)

## LED Behavior when Battery Charger is Connected to Power Dock or Scanner

When the battery charger is connected to the power source, its LED displays the charging state as described in the table below. (Blinking = charging. Not blinking= not charging.)

Color	State
Violet blinking	Battery charging. Charge at < 5%
Red blinking	Battery charging. Charge at 5% - 15%
Orange blinking	Battery charging. Charge at 15% - 25%
Yellow blinking	Battery charging. Charge at 25% - 95%
Green blinking	Battery charging. Charge at >95%
Green	(full charged) ~100%
White	no battery
Cyan blinking quickly	error

## Maintenance of Power Dock Battery Charger

The Power Dock battery charger does not require much maintenance. If the charger becomes dirty or dusty, clean it with a soft dry cloth. If necessary, dampen the cloth with isopropyl alcohol. Always unplug the Power Dock Battery Charger and remove the battery before cleaning with alcohol. Be cautious and do not damage or bend the connectors.

## Status Indicator

The status indicator enables you to see the scanner's LED colors and blink codes from more positions and from a greater distance. The scanner's LED indicator on the on/off button is switched off when the status indicator is installed.

The status indicator is suitable for indoor or outdoor use.

The light of the status indicator is visible from all sides of the scanner except the side with the touch screen.

The status indicator can function no matter the orientation of the scanner—even if it is upside-down.



Figure 4-6 : Status Indicator

---

**NOTICE:** The status indicator is not waterproof. Do not use the indicator in the rain, or where water could drip onto it.

---

## Inserting the status indicator

1. Check the gold plated contact pins of the status indicator before inserting it into the accessory bay. Clean with a dry cotton swab if necessary.
2. Ensure that the laser scanner is switched off.
3. Remove the protective cover from the accessory bay on the right side of the scanner ①. To remove the cover:
  - a. The cover is removed by pressing down on one side of the cover (indicated by ①), which causes the other side to pop up.
  - b. Grasp the side that is now elevated from both sides and pull the cover completely out of the bay.
  - c. Place the protective cover in the small slot in the case foam located beside the USB card reader.
4. Insert the status indicator into the accessory bay. The correct bay is colored red.

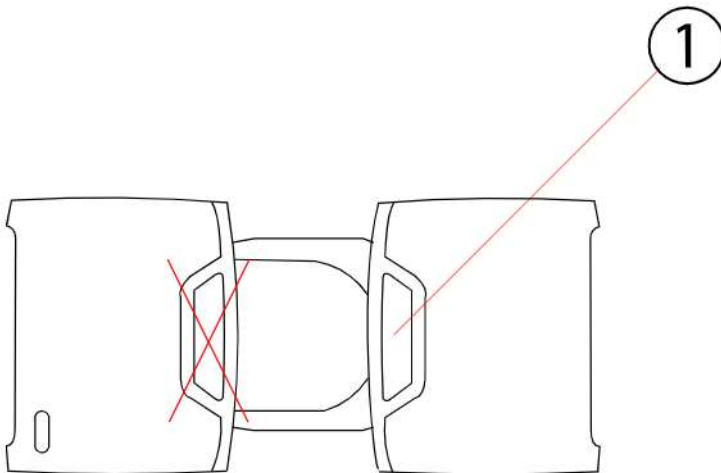


Figure 4-7 : Accessory bay for the status indicator with covers

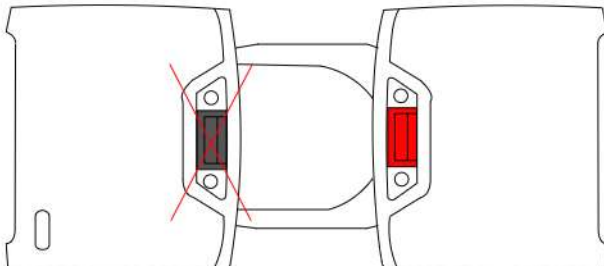


Figure 4-8 : Accessory bay for the status indicator with covers removed

---

**NOTICE:** Do not insert the status indicator into the accessory bay on the left side of the scanner.  
Forcing the status indicator into the black bay may damage either the status indicator, the scanner, or both.

---

The status indicator is now ready for use. Switch on the scanner and use it as you normally would. The color and blink codes are identical to the scanner's LED power on/off button.

## Removing the status indicator

1. Switch off the scanner.
2. Remove the status indicator by grasping it with two fingers on the corners shown in [Figure 4-9](#) and pulling vertically.

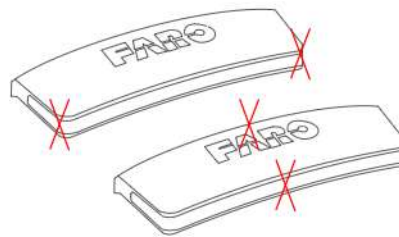


Figure 4-9 : Pull here to remove

Figure 4-10 : Do not pull here

3. Replace the accessory bay cover after removing the status indicator.
4. Store the status indicator in a cloth bag or other soft carrying case that will prevent the gold-plated contacts from being scratched.

## Chapter 5: Getting Started

This chapter provides preliminary steps and basic FARO Focus Premium operation instructions as well as guiding you step-by-step from setting up the FARO Focus Premium to recording your first scan.

### Charging the Battery

The Power Block battery (ACCS-PWR-0014) can be charged in the FARO Focus Premium or in the FARO Power Dock battery charger (ACCS-PWR-0013).

As a safety precaution, new batteries are shipped with a charge of less than 30%. New batteries must be completely charged before first use. Full capacity of a new battery will only be reached after a couple of charge/discharge cycles. We recommend fully charging the battery before each use. Keep a spare battery, if necessary, during your scan project.

---

**DANGER: Danger of explosion or fire** Do not immerse batteries in water or fire. Do not bring metal objects into contact with the battery terminals. The terminals may short-circuit and over-heat.

---

---

**DANGER: Danger of fire or electric shocks** Ensure that the devices are protected from rain or spraying water. The power-supply unit and the Power Dock battery charger are not intended for outdoor use.

---

The power-supply unit can be used in various countries. It is compatible with a 100 V AC to 240 V AC 50/60 Hz power source. Use a voltage adapter, if necessary.

### Charging the Battery in the FARO Focus Premium

---

**NOTICE:** You cannot use older versions of the battery (versions that were used for the Focus S, M and S+ scanners) with the Focus Premium Laser Scanner. These batteries do not provide enough current to safely power and operate the Focus Premium Laser Scanner. Use only version ACCS-PWR-0014 of the battery. The scanner will warn you if you try to start it using an older battery. If you have both types of batteries, always double-check the battery's type label to ensure you have the right version—especially when packing for a remote job.

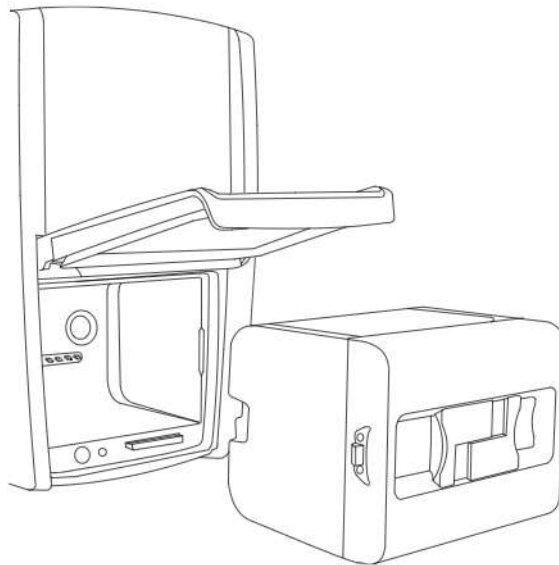
---

1. Open the scanner's battery compartment cover.
2. Turn the battery so that its type label is directed upwards.
3. Point the battery contacts toward the scanner.
4. Push the battery straight in, sliding it into the battery compartment until the fastener clicks into position.

---

**NOTICE:** Never apply force while inserting the battery. If the battery does not slide gently into place, check again for correct alignment.

---



*Figure 5-1 FARO Focus Premium with Battery*

5. Connect the cable of the power-supply unit to the power socket of the FARO Focus Premium.

---

**NOTICE:** If you use force while inserting the plug in a wrong direction, the plug and the FARO Focus Premium can be damaged.

---

6. Connect the AC power cable to the power-supply unit and a power outlet. Check the input voltage on the type label before connecting.
7. If the FARO Focus Premium is turned off, the scanner LEDs start blinking while charging. The LEDs stop blinking and illuminate a constant green, when the battery is fully charged.
8. If the FARO Focus Premium is turned on, check the battery's charging state in the scanner's user interface under **Manage > General Settings > Power Management**.

9. When charging is finished, remove the power-supply unit's cable. Close the battery compartment cover.

---

**NOTICE:** Do not operate the scanner while the external power-supply is plugged in, because the power cable might damage the turning scanner.

---

The FARO Focus Premium does not need to be switched on to charge the battery.

---

**NOTE:** Remove FARO Focus Premium from the transport case before connecting the power-supply to the scanner. Before prolonged storage, remove the power-supply unit and the battery.

---

## Charging the Battery with the Power Dock Battery Charger

---

**NOTICE:** Do not leave the battery in the Power Dock when it is not being charged, as this can result in a deep discharge state from which the battery cannot be recharged.

---

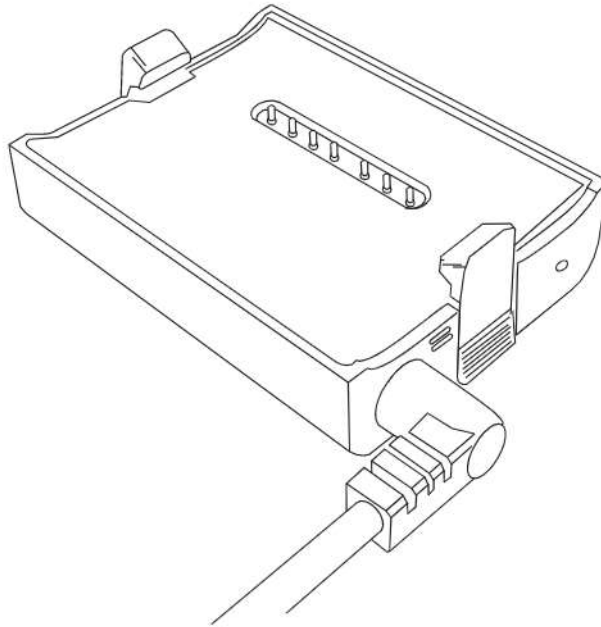


1. Connect the power-supply unit's cable to the power socket of the FARO Power Dock battery charger. Do not use force while inserting the plug in the wrong direction, or the plug and the Power Dock battery charger can be damaged.

---

**NOTICE:** Place the FARO Power Dock battery charger on a flat, non-slip surface. Ensure that the cable is positioned, so that it cannot accidentally be pulled by passing objects. If the Power Dock is dropped, check the device and replace if damaged.

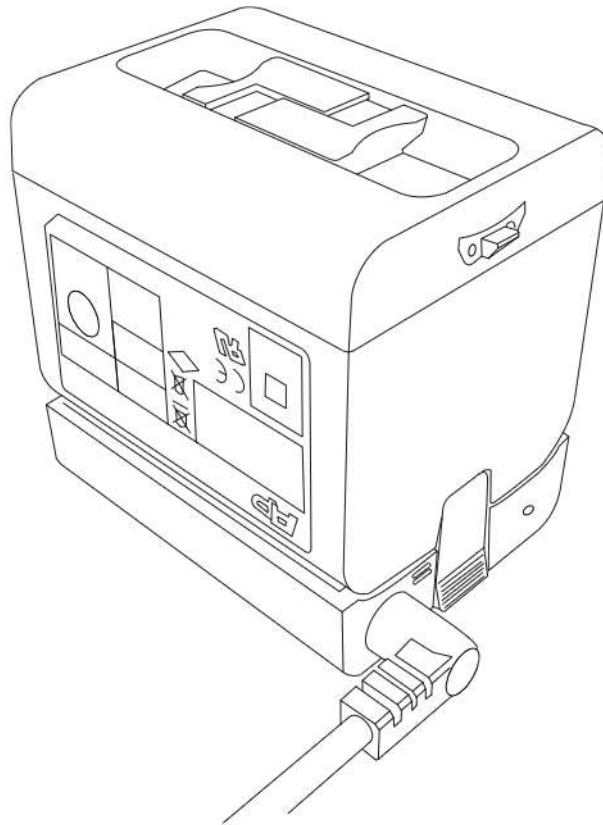
---



*Figure 5-2 Power Dock battery charger with connected power cable*

2. Connect the AC power cable to the power-supply unit and a power outlet. Check the input voltage on the type label before connecting.
3. The LED of the Power Dock battery charger illuminates white for ACCS-PWR-0013, when power is correctly connected

4. Place the battery on top of the Power Dock battery charger. Ensure that the battery terminals are aligned correctly with the pins of the charger. Snap the battery into place.



*Figure 5-3 Placing the battery on the Power Dock battery charger*

5. Charging starts automatically; the LED blinks and illuminates according to the current charging state of the battery. See [Power Dock Battery Charger on page 19](#)

After charging, carefully press the charger interlock mechanism and remove the battery.

---

**NOTICE:** Check the Power Dock for damage before use, being sure to check that the safety clamps have not been damaged, which can occur if the Power Dock falls while holding a Power Block.

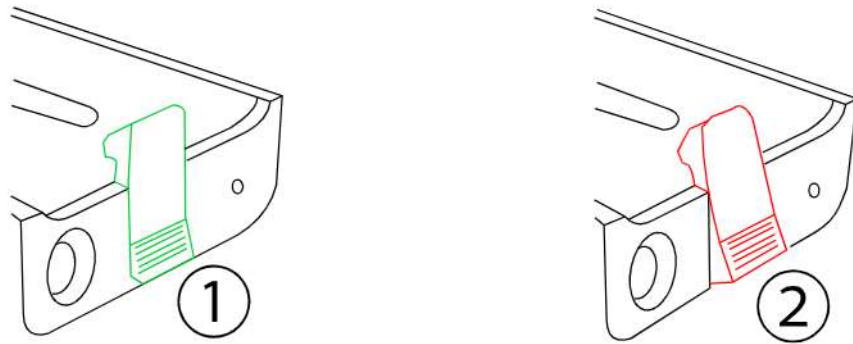


Figure 5-4 Undamaged vs damaged safety latch

- ① **Undamaged safety latch** - Note the *vertical* position.
- ② **Damaged safety latch** - Note the *slanted* position.

---

**NOTICE:** Do not use a damaged Power Dock. Doing so may damage the Power Block.

---

## Tips for Using the Battery

- Charge the battery the day of use, or the day before. An unused, charged battery gradually loses its charge.
- If the battery empties quickly after being fully-charged, replace it with a new one.
- For optimal battery performance, an ambient temperature of 0 °C to +40 °C (+32 °F to +104 °F) is recommended. In colder or warmer locations, battery performance and operation time may temporarily decrease and charge time may increase. If the battery temperature is too high, it may not charge at all until the battery cools down.

## Setting up the FARO Focus Premium

---

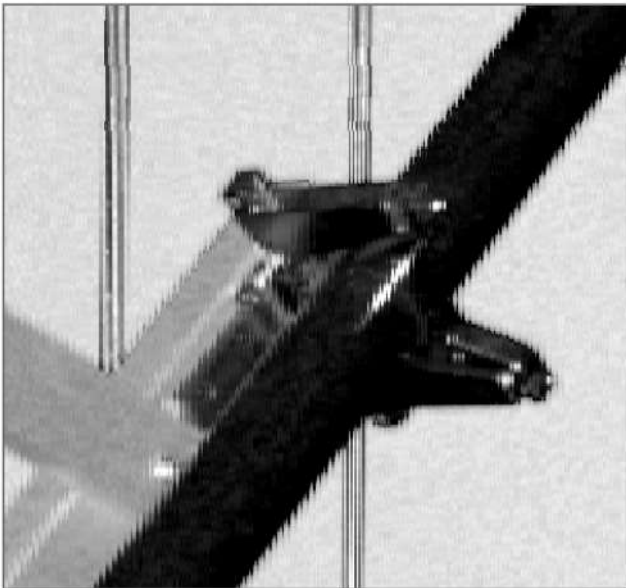
**WARNING: Danger of injuries, especially to children or kneeling persons**

Injuries may result, if the FARO Focus Premium overturns.

- The FARO Focus Premium may only be used on a flat, stable surface.
  - If using a cart or tripod dolly, move the setup with special care. Never move the cart by pulling at the power cables. Pushing or pulling the cart with too much force, sudden stops, or over an uneven surface can upset of the FARO Focus Premium.
  - In windy conditions, use sandbags to stabilize each foot of the tripod. You can also place a weight on the ground under the tripod, then stretch a rope or shock cord between the tripod's center hook and the weight.
- 

## Setting up the Tripod

For optimal performance, the base on which the scanner rests must be *absolutely* motionless. Any vibration or oscillation in the tripod or the ground on which the tripod stands can reduce the accuracy of the scan, and can lead to fringed or ghost lines, as shown below.



*Figure 5-5 Sample scan result due to scanner vibration during data acquisition*

Use a high-quality tripod. FARO recommends the GITZO ACCSS8032, available only from your FARO sales representative.

---

**NOTICE:** When adjusting the height of the tripod, assure that the scanner is NOT mounted. During leg adjustment, the tripod may become temporarily unstable, and could tip over, causing damage to the scanner.

---

## While Working with the Laser Scanner

- Due to long recording times and high data-quality requirements, you must ensure that the tripod is as stable as possible.
- Because a laser scanner moves during operation, the tripod must always be as rigid as possible.

## To Achieve Stability and Rigidity

- Extend the tripod as little as possible. Less height means more accuracy.
- Extend the thicker segments of the legs before the thinner.
- You can extend a leg segment partially, if necessary, to achieve a specific height, but do not partially extend several segments of the same leg.
- The tripod has four leg segments, three of which are extendable. Fully extend segment ②, leaving segments ③ and ④ collapsed. This results in a working height of approximately 130 cm (51.2 in).
- The tripod is equipped with large, adjustable rubber feet. Each time you move the tripod, ensure that the feet are correctly resting on the ground. If you need to place the tripod on unstable ground (e.g., grass, gravel, mud), use the supplied spikes instead of the rubber feet. Press the spikes individually into the ground until they reach a stable, load-bearing layer.
- After you set the tripod on the ground, check the leg latches. If any latches are loose, spread the legs slightly until the latches cannot be wiggled. This ensures that the tripod is firmly planted on the ground, and unlikely to shake or vibrate during scanning.
- The use of the center column significantly reduces the rigidity of the tripod. We recommend that you avoid using the center column. If you need higher working heights, we recommend using a larger tripod. Make sure that a such a tripod is also stable.

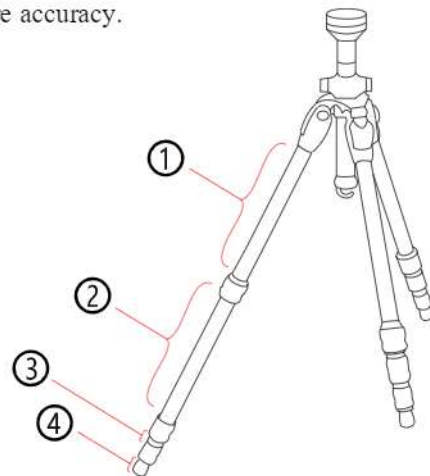


Figure 5-6 Tripod

- For scans close to the ground, slide all leg segments into each other before setting the leg angle to flat. The rubber feet have a recess that helps to achieve full-surface contact, even with a flat leg angle. To do this, turn the feet individually by hand.
- Ensure that the twist-lock sleeves for leg length adjustment, the central wing nut of the tripod shoulder, and the tripod head are always tightly screwed together.
- To achieve a better grip on hard surfaces, slightly tension the tripod legs before starting a scan. Tension the legs by holding two of the three tripod legs as close to the ground as possible with your hands, pulling them slightly apart from each other and away from the third leg, then pressing them into the ground.
- Under windy conditions, use sandbags to stabilize each foot of the tripod. You can also stretch a rope or shock cord between the tripod's center hook and a weight, switchable magnetic base, or existing anchor point.

## Inverting the scanner

The scanner can be mounted upside-down. In an inverted position, the scanner's documented IP rating is no longer valid, so take care to prevent water from dripping on the scanner.

- Ensure that no person is underneath the scanner during setup and operation.
- The setup you create to hold the scanner should be able to support at least 5 kg (11 lbs.).
- Use a tripod only if it is suitable for inverted installations (the ACCSS8032 tripod is not suitable).
- The setup must be as rigid as possible and must prevent vibrations and oscillations.
- Ensure that the scanner can not loosen or fall from your setup. Make sure your mounting is locked safely and can not open under weight.
- Ensure that the scanner can rotate without touching anything.
- Keep the cooling fan openings uncovered and at least 18 cm (7 in) from any surface.

## Mounting and Using the Quick Release

The quick release enables you to quickly and safely attach and remove the scanner from the tripod. The quick release consists of these parts:

- ① Scanner plate ② Fixation screw ③ Center spindle ④ Spindle screw ⑤ Tripod plate

### Prepare the Tripod

1. Extend the tripod legs and place the tripod on a stable surface at a convenient height. Ensure that all legs of the tripod are secure.
2. Your tripod might be equipped with one or more set screws in the platform. Ensure that the set screws are recessed below the platform. They must not stick up out of the surface.
3. Place the tripod plate over the center screw of the tripod.
4. Ensure that the spindle screw is firmly screwed into the narrow side of the center spindle.
5. Screw the center spindle firmly onto the tripod.

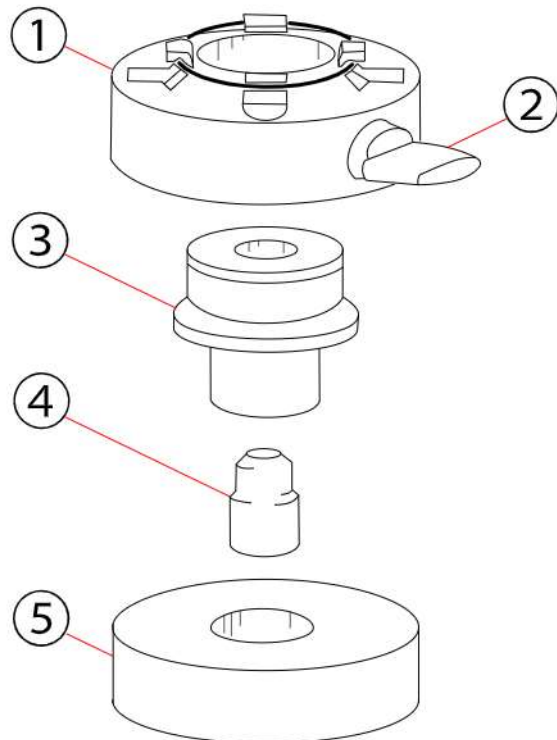


Figure 5-7 Quick release parts

### Prepare the Scanner

1. Place the scanner upside down on a stable, flat surface. Use the included mirror protection foam to protect the mirror from dirt, dust, or falling objects.
2. Place the scanner plate onto the base of the scanner. Ensure that it slides into the circular depression surrounding the center thread.
3. Use a 4 mm hex key to tighten the four screws, so that the scanner plate is firmly attached to the scanner. Tighten the screws crosswise. Do not over-tighten.
4. Extend the tripod legs and place the tripod on a stable surface at a convenient height. Ensure that all legs of the tripod are secure.

## Use the Quick Release

1. Ensure that the tripod is level and the tripod plate is firmly attached to the tripod. Tighten manually, if necessary.
2. Ensure that the fixation screw in the scanner plate is unscrewed, so that it won't block the scanner plate from sliding over the center spindle.
3. Holding the scanner from both sides, slide the scanner plate over the center spindle.
4. Manually tighten the fixation screw until the scanner plate is firmly attached to the center spindle.

You can now use the scanner.

To remove the scanner, loosen the fixation screw and lift the scanner from the center spindle.

## SD Card

### Preparing an SD Card

The FARO Focus Premium exports recorded scans on a removable SD card. This memory card can also be used to create backups of the scanner settings, to import scanner settings, and to install firmware updates.

SDHC or SDXC cards are highly recommended. Memory cards with a size up to 512 GB have been verified to operate with the scanner. The speed of the card must be Class 10/V30 or better.

---

**NOTE:** The SD card must be formatted in the exFAT file system. When using an SD card other than one supplied with the scanner, format it with the scanner format function first. See [Service on page 98](#).

---

SDHC cards may also be formatted with Windows. SDXC cards with a capacity of more than 32 GB cannot be formatted with the Windows format function, because Windows formats them in its own file system. The Windows file system is not supported by the scanner. There are freeware tools that allow formatting these cards with Windows as exFAT, but we strongly recommend using the scanner's format function.



---

**NOTICE: Risk of data loss.**

Do not remove the SD card from the scanner while it is busy, otherwise you risk corrupting the data on the card. A busy SD card is indicated by the SD card icon blinking in the status bar of the Focus user interface. It is safe to remove the card from the scanner when this icon has disappeared.

When removing a FARO Focus Premium SD card from your computer, always use the **Safely Remove Hardware** option from the Windows system tray, otherwise you risk corrupting the data on the SD card. To safely remove hardware in Windows, right-click in the system tray, double-click **Safely Remove Hardware** in the context menu, then select the device you want to remove.

---

## Structure of the SD Card

The SD card in the scanner saves information in various folders.

### Scan-related data

- **Backup** - Scanner backups are saved to this folder. The backup folder is automatically created as soon as you start a scanner backup. See [Service on page 98](#).
- **Scans** - The captured scans are saved to this folder. The scans folder is automatically created as soon as a scan has been started. See [Starting a Scan on page 49](#).
- **Is-data**: Binary object and meta data is saved in this folder. The folder is automatically created by the scanner. Do not manipulate, delete or move any of this data.
- **index-v2**: Index file. This file is automatically created by the scanner. Do not manipulate, delete or move this file.

### Logfile and Updates

**Logfile** - When exporting the log files from the scanner, they are saved to this folder. This folder is automatically created by the scanner. See [Service on page 98](#).

**Updates** - Copy firmware updates to this folder. This folder must be manually created. See [Firmware Update on page 100](#).

## Inserting the SD Card

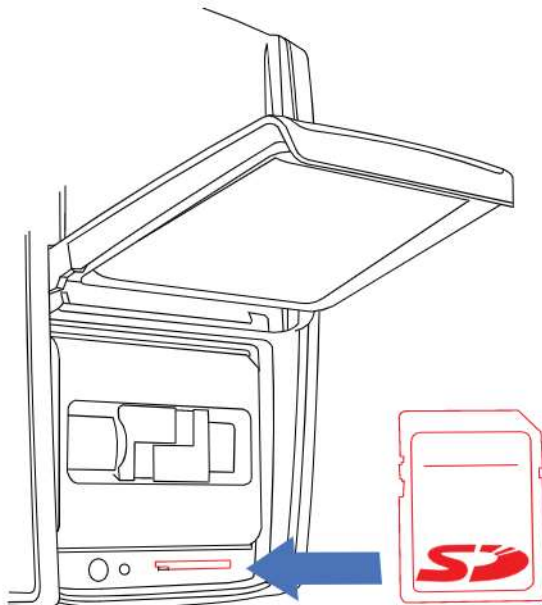


Figure 5-8 Inserting the SD Card

1. Open the battery compartment cover. The SD card slot is in the lower right corner.
2. Insert the formatted SD card with the notched edge in the direction as illustrated until it clicks.

---

**NOTICE:** Confirm the direction of the memory card before inserting. Using force to insert the memory card in a wrong direction can damage the SD card, card slot, or data on the card.

---

3. Close the cover.

## Ejecting the SD Card

To remove an SD card from the scanner, open the SD card slot cover and lightly push the memory card until it slightly springs out.

---

**NOTICE:** Do not eject the memory card while in-use.

Do not let the memory card release from the slot and fall.

---

## Switching on the FARO Focus Premium

Pressing the scanner's **On/Off button** starts the boot process, indicated by the scanner LEDs blinking blue. If power is supplied by the battery and its charge state is too low to start the scanner, the scanner LEDs blink red.

When the FARO Focus Premium is ready, the LEDs stop flashing and illuminate a constantly blue. The scanner controller software's home screen appears on the integrated touch screen.

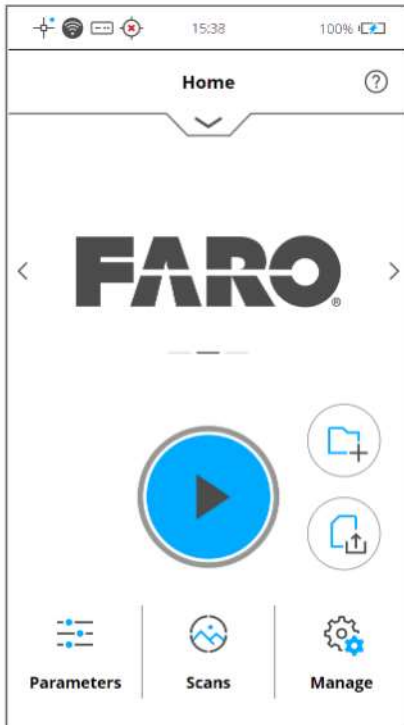


Figure 5-9 Home Screen of the controller software

To operate, tap the elements on the screen with your fingers. You can also use a capacitive stylus to navigate through the user interface.

## Initial Scanner Settings

This chapter gives you a brief description on how to set up initial scanner settings using the scanner's controller software on the integrated touch screen. See [Controller Software on page 54 for more information](#).

## Setting the Interface Language


From the Home Screen, tap  **Manage** > **General Settings** > **Language** to change the language of the controller software.



Figure 5-10 Language Selection Screen Check

Select the language by tapping the desired language. The selected language is highlighted.


If the list of available languages exceeds the screen size, scroll up or down.

## Setting the Date and Time

---

**NOTE:** If the scanner is not switched on for circa 60 days, the system date and time will be lost and must be reset before scanning to ensure that the time and date of all project files and scans is correct.

---

To change the date and time settings, from the Home Screen, tap  **Manage** > **General Settings** > **Date & Time**.

**Automatic date and time** - Tap and slide to activate automatic date and time settings.

**24-Hour Clock** - Tap to set the time format. The scanner can display time in either the 24-hour or the 12-hour clock format. Slide to ON to select the 24-hour clock. Slide to OFF to select the 12-hour clock.

**Select Date Format** - Tap to choose the date format. The currently selected date format is displayed. Select between the date formats DD.MM.YYY, MM/DD/YYYY or YYYY-MM-DD, where YYYY is the year, DD the day and MM the month. The selected format is highlighted.

**Select time zone** - Tap to select the time zone. The currently selected time zone is displayed.

**Change date and time** - Tap to set the internal clock. (Only available if Automatic date and time is turned off.)

## Setting the Unit of Length and the Temperature Scale

Home Screen >  Manage > General Settings > Units.

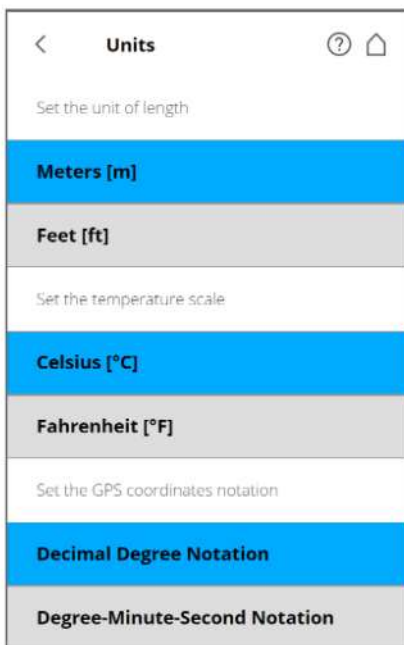


Figure 5-11 Change Unit of Length

Lengths are displayed by the controller software in either in meters or feet. Select the desired unit of length by tapping the corresponding button.

Temperatures are displayed in either Celsius or Fahrenheit. Select the desired unit by tapping the corresponding button.

GPS coordinates are displayed in either decimal degree notation (e.g., +34.9823450 °E) or degree-minute-second notation (e.g., 34° 58' 56.44" E).

## Scanner Details

### **Manage > General Settings > Scanner Details**

You can specify a scanner name and the owner of the FARO Focus Premium. By default the scanner name is the serial number of the scanner.

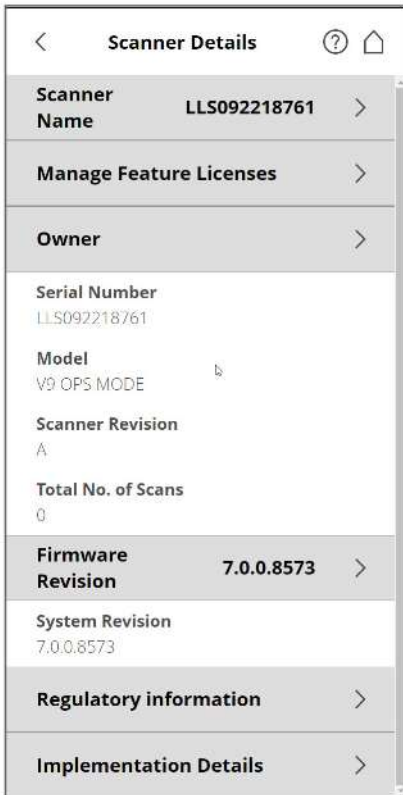


Figure 5-12 Scanner Details

**Scanner name** - Tap to change the name of the scanner.

**Manage Feature Licenses:** Tap to add and manage additional feature licenses (e.g., range extensions or Swift licenses). Contact your FARO sales representative for further information.

**Owner** - Tap to enter the name of the company or person, who owns the scanner.

See also [Scanner Details on page 96](#).

## Scanning

This chapter gives you a brief description on how to set the scanning parameters to capture your first scans. Normally, you would provide and enter project information before starting with your scan project. This is described later. See [Scan Projects and Clusters on page 71](#).

## FARO Stream

FARO Stream is an app for your phone that enables you to control a FARO laser scanner, get a real-time view of the scan progress as it happens, add text and picture annotations to the scan, pre-register scans, and upload the project to the cloud. This can help you be certain that you have correctly captured the scan environment while still on-site.

## Setting the Scanning Parameters

Resolution, quality, or scanning angles are the parameters used by the scanner for recording the scan data. There are two ways to set the scanning parameters:

- Change them manually.
- Select a scan profile. These are predefined sets of scanning parameters.

When selecting a scan profile, its settings overwrite the scanning parameters.

To choose a predefined scan profile, or change the scanning parameters, tap **Parameters**.

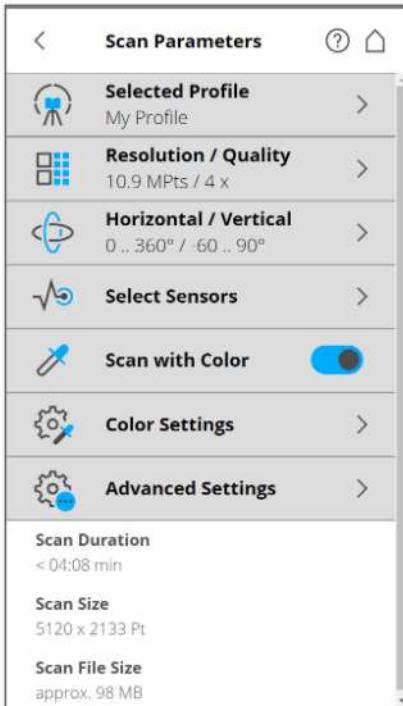


Figure 5-13 Change the Scan Parameters

**Selected Profile** - Shows the name of the selected scan profile. Tap to select a scan profile. If the scanning parameters differ from the selected profile, *altered* is appended to its name.

---

**NOTE:** Selecting a predefined scan profile overwrites all current scanning parameters with the settings of the selected scan profile.

---

You can also edit the scanning parameters individually by changing the following settings by tapping to edit:

**Resolution and Quality** - Displays the selected resolution in megapoints, as well as the selected quality.

**Horizontal and Vertical Scan Range** - Displays the scan range with the horizontal and vertical start and end angles in degrees.

**Select Sensors** - Opens the screen to enable or disable automatic use of built-in sensors' data for the scan registration in SCENE or Sphere.

**Scan with Color** - Switch colored scan recording on or off. If switched on, the scanner also takes color photos of the scanned environment with the integrated color camera or PanoCam accessory, if attached. These photos are taken right after the laser scan and are used in the point cloud processing software SCENE or Sphere to automatically colorize the recorded scan data.

**Color Settings** - Shows the current exposure metering mode used for taking color photos. You can also choose whether to use the integrated camera or the PanoCam, an accessory available from FARO. (For more details about PanoCam refer to the [Accessories Manual for the Focus Laser Scanner](#).)

**Advanced Settings** - Enable or disable the Clear Contour and Clear Sky filters. Enable or disable the Far Distance.

**Scan Size [Pt]** - Shows the scan size in points horizontal x vertical measurement. The vertical size can only be changed by setting a new resolution or changing the scan area angle.

**Scan Duration, Scan File Size** - Expected scan time and file size in megabytes depending on the chosen settings, including pre and post-processing, resolution, selected exposure metering, scan area, quality value, and scan range. Note that the values shown here are approximate values because color scan times can vary because of particular exposure times required by lighting conditions at your scan site.

## Selecting a Scan Profile

Prior to capturing a scan, you can select a scan profile that fits the needs of the scene and the desired scan quality.

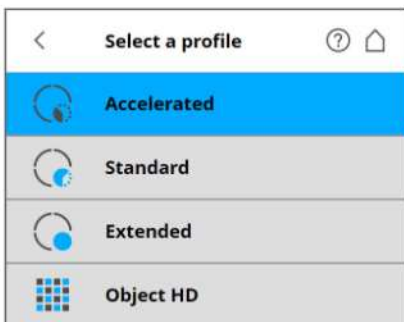



Figure 5-14 Select a Profile



This view shows a list of all available scan profiles. The list contains factory predefined profiles that are read-only and custom profiles that can be created and manipulated under  **Manage > Profiles**.

See [Service on page 98](#) for an overview of the available factory predefined scan profiles. See [Selected Profile on page 67](#)

Select a profile by tapping it. The selected profile is highlighted.

## Setting Resolution and Quality

**Resolution** - The resulting scan resolution. Choose from 1/1, 1/2, 1/4, 1/5, 1/8, 1/10, 1/16, 1/20 and 1/32.

**Quality** - The quality of the scan and the scanning time at constant scan resolutions. You can balance the quality and speed. If speed is more important, choose lower values. If the quality of the scan data is more important, choose higher values.

The resulting scan duration, vertical and horizontal scan points (Scan Size [Pt]), as well as scan size in megapoints (MPs) is displayed in the middle of the view. Point distance [mm/10 m] / [in/30 ft] is the distance between the captured scan points in mm (in) within a scan distance of 10 meters (30 ft).

---

**NOTE:** The unambiguity interval specifies the maximum distance at which the scanner can accurately measure points with the selected settings. For technical reasons, points created for objects farther than this distance appear much closer to the scanner than what the objects actually are.

If this happens, remove the points later using the SCENE software. This can be time-consuming. It is quicker to choose a combination of resolution and quality with an unambiguity interval that is larger than the most distant object to be scanned.

---

## Setting the Scan Range (Scan Area)

Parameters > Horizontal / Vertical

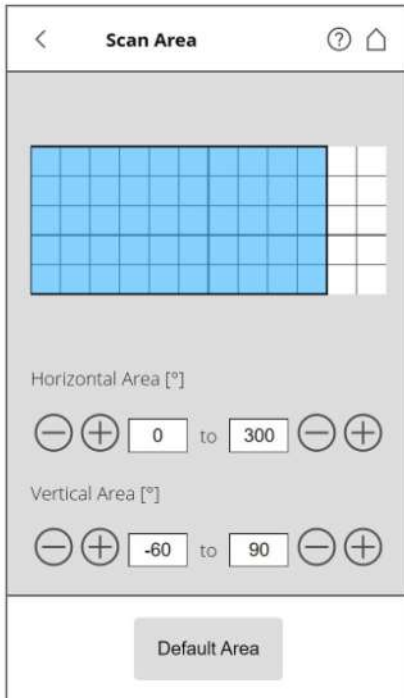


Figure 5-15 Setting the Scan Range

**Vertical area** - The size of the vertical scan area in degrees. Tap the fields to enter the values of the vertical start and end angles.

**Horizontal area** - The size of the horizontal scan area in degrees. Tap the fields to enter the values of the horizontal start and end angles.

**Default Area** - Tap to reset the values to the default scan area (vertical from  $-60^{\circ}$  to  $90^{\circ}$  and horizontal from  $0^{\circ}$  to  $360^{\circ}$ ).

The rectangle in this view illustrates the full scan area. If there are scans saved on your selected storage medium, the preview picture of the last recorded scan is displayed. If there is no preview picture available, a grid is displayed, where the space between the horizontal and vertical lines is equivalent to  $30^{\circ}$ . The highlighted rectangle illustrates the selected scan area.

## Selecting the Sensors

Parameters > Select Sensors

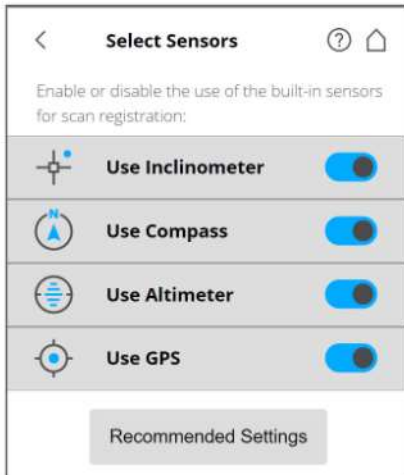


Figure 5-16 Selecting the Sensors

**Use Inclinometer** - Enable or disable the automatic use of the inclination measurement of the built-in dual-axis compensator (inclinometer) for the scan registration in SCENE or Sphere. Regardless of your setting, this sensor's data is always measured and attached to each scan. If the inclinometer data is enabled, it is automatically used to register the scans; if it is disabled, the data is ignored. You can change this behavior later in SCENE. See the SCENE User Manual for more information. Jump directly to **Use Inclinometer** by tapping the quick access icon (⊕) at the top of the screen.

---

**NOTE:** To get the most reliable data from the dual-axis compensator, ensure that the scanner's inclination is less than 2°. See [Inclinometer \(Dual-Axis Compensator\)](#) on page 81.

---


**Use Compass** - Enable or disable the automatic use of the built-in compass' data for the scan registration in SCENE or Sphere. The compass' data is always measured and attached to each scan during scanning and is automatically used for the scan registration, if is enabled. If it is disabled, the data is ignored. See [Compass](#) on page 83.

---

**NOTICE:** Ferromagnetic objects and electromagnetic fields can disturb the earth magnetic field. This, as well as local variations in earth magnetic field (magnetic declination/variation) can lead to inaccurate compass measurements. In this case it's recommended to switch off the use of the compass data.

---

**Use Altimeter** - Enable or disable the automatic use of the altimeter data for the scan registration in SCENE or Sphere. As with the inclinometer, the altimeter data is always measured and attached to each scan during scanning and is automatically used for the scan registration, if it is enabled. You can enter a reference height before starting your scan project. This reference height acts as the basis for all

measurements made by the altimeter. Find the altimeter settings under  **Manage** > **Sensors** > **Altimeter**. See [Altimeter](#) on page 85.

**Use GPS** - Turns the GPS sensor ON or OFF. Unlike the other sensors, the GPS data is only recorded during scanning and is thus only available for scan registration in SCENE, if this is switched to ON. Note that a GPS signal may not be available when scanning indoors. See [GPS](#) on page 84.

**Recommended Settings** - Enable all sensors. Remember that the use of the inclinometer will increase the scan time.

## Color Settings

### Parameters > Color Settings

There are two options to capture and colorize scans:

- The integrated camera, see section below
- The PanoCam (an additional accessory available from FARO. For more details about PanoCam refer to the [Accessories Manual for the Focus Laser Scanner](#).)

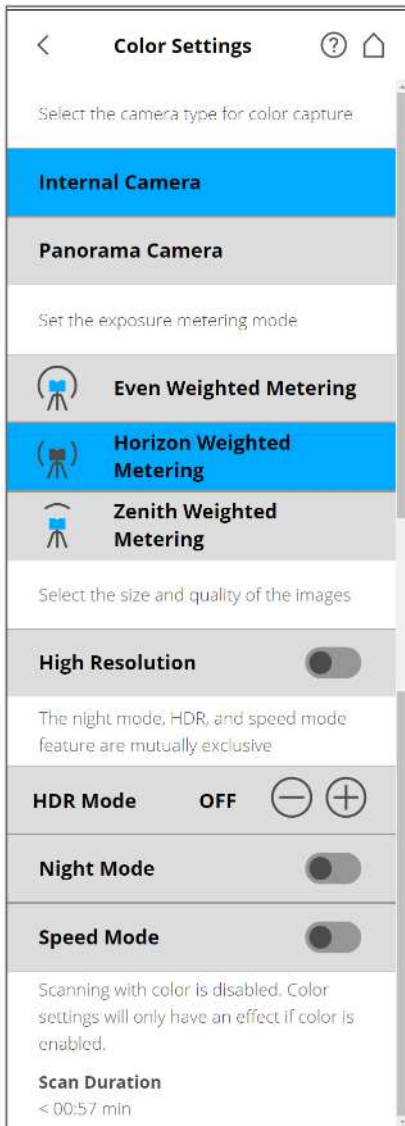


Figure 5-17 Color Settings

**Set the exposure metering mode** - Set how the integrated color camera determines the exposure for taking the color photos, if colored scan recording is switched on.

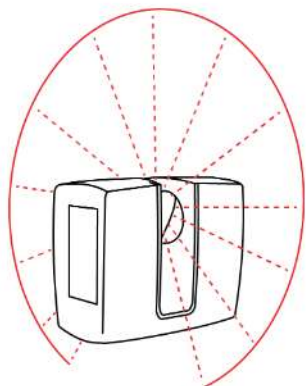


Figure 5-18 Even weighted metering

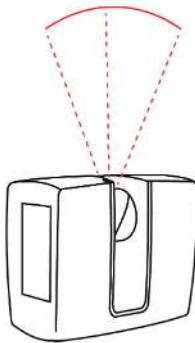


Figure 5-19 Zenith weighted metering

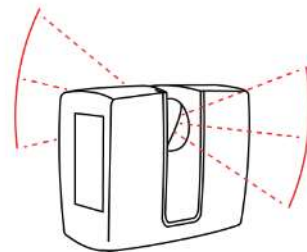


Figure 5-20 Horizon weighted metering

**Even Weighted Metering** - Determine the exposure settings the camera uses regarding the light information coming from the entire scene, and averages without giving weighting to a particular area. Even weighted is the default for accelerated, standard, and extended profiles.

**Horizon Weighted Metering** - The camera uses the light information coming from the horizon to determine the exposure setting. This mode is commonly used in scenarios with bright light coming from directly above (e.g., indoors with bright ceiling lighting or outdoors with bright sunlight coming from directly above), or to achieve the best balance of light and exposure for objects at the horizon. Compared to even-weighted metering, this increases scan duration by approximately 14 seconds.

If the vertical scan area is limited, then the area used to determine the exposure (i.e., the exposure metering area) might not be near the horizon. This is the case, if the vertical start angle is set to  $> -30^\circ$ , or if the vertical end angle is set to  $< 30^\circ$ . The exposure metering area is then be moved up or down, and set to the center of the remaining vertical scan area. The following figures illustrate this:



Figure 5-21 Exposure metering area (highlighted yellow) for the full vertical scan area



Figure 5-22 Exposure metering area for a limited vertical scan area set to e.g.,  $10^\circ$  to  $90^\circ$

**Zenith Weighted Metering** - With zenith weighted metering, the camera uses the light information coming from above the scanner to determine its exposure setting. Use this mode when there is very bright light coming from windows, for example, and you want to achieve the most correct balance of light and exposure for objects on the ceiling of building.

**High Resolution**- With high resolution enabled, the full 13 MPx resolution of internal camera is used. This improves colorization quality in SCENE and Sphere. Note, though, that this increases the file size and processing times. Only activate this option if the best quality colorization is required. If this option

is turned off the 13 MPx image is down-sampled to 8 MPx and used for colorization (identical to Focus<sup>S</sup> and Focus<sup>S</sup> Plus models).

## HDR Mode

---

**NOTE:** The HDR, Night, and Speed modes are mutually exclusive.

---

The High Dynamic Range (HDR) imaging method merges images captured with different exposure settings into a single image with a greater dynamic range of luminosity.

### Scanning with HDR Capturing

Set the HDR capturing by tapping + or -, ranging from 2x to 5x. This setting corresponds to the exposure levels. If no option is selected, then OFF is displayed.

---

**NOTE:** When HDR is enabled, a larger number of captured images result in a longer capturing time. The processing time is thus longer in SCENE or Sphere.

---

## Night Mode

Select night mode to improve the quality of color photos under relatively dark lighting conditions. Enabling night mode significantly increases the scan duration.

---

**NOTE:** For best scanning results, enable **Night Mode** in combination with either **Horizon Weighted Metering** or **Zenith Weighted Metering**. Very dark lighting conditions may lead to a poor picture quality, even if night mode is activated. This can lead to grainy images and other artifacts.

---

## Speed Mode

Select Speed Mode to reduce the scan duration. This happens at the cost of color picture quality. This mode is fastest and should be used in bright environments.

## Advanced Settings

 Parameters > Advanced Settings

**Clear Contour** - Enables the dynamic contour filter. This hardware filter removes scan points that resulted from the laser spot hitting two objects. This usually happens at the edges of objects.

**Clear Sky** - Enables the dynamic sky filter. During scanning, this hardware filter removes scan points resulting from scanning empty spaces in the sky.

**Distance Range** - The Distance Range setting configures the scanner to increase the quality of the points captured at specified distances.

- **Normal** - Select this to scan most objects.
- **Near** - Select this to scan objects that are near the scanner, especially when the objects are reflective.
- **Far Distances** - Select this when scanning outer-lying spaces, where the scan surfaces are located at distances of greater than 20 meters from the scanner. This setting is not recommended for indoor scanning.

**Recommended Settings** - Enables the Clear Contour and Clear Sky filters. Disables Far Distance Optimization.

## Starting a Scan

Remember that the scanner is turning and the mirror unit is rotating at high speeds. Ensure that the scanner can freely move, and that the mirror cannot hit any objects.

Start scanning by tapping on **Start Scan** on the controller software's home screen, or use the Stream app on your phone. After starting the scanner, a full 360° reference run is performed to initialize the pan axis. This will not occur for subsequent scans.

---

**NOTE:** If there is not enough space on the SSD or SD, you are warned and the scanner refuses to scan. Remove scan data from the SSD or SD using the storage management feature. Refer to [Storage Management on page 101](#)

---

When the scan process starts, the scanner's laser is switched ON. The scanner's LEDs blink red as long as the scanner's laser is switched ON. During scanning, the scanner rotates 180° clockwise. If you are scanning with color, the scanner continues to turn for a total of 360° to take the pictures.

---

**NOTE:** If pictures are taken that include objects that were *not* scanned by the laser, e.g., if a person or vehicle moves into the camera's field-of-view, you can retake the pictures, if this feature is enabled before scanning. See [Retaking Pictures on page 119](#)

---

The executed processing steps are displayed in the status area of the scanning screen. The time remaining is indicated by a timer. Tap the drop-down tab to display more information about the scan. The figure below shows the expanded tab.



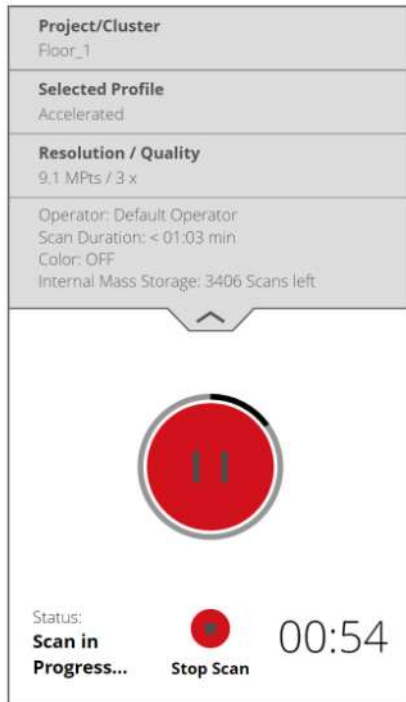


Figure 5-23 Scanning View

During most of the scanning process, a scan can be paused using the pause button. You can pause to avoid scanning a moving object, such as a car or piece of machinery, for example. Resume scanning by tapping the resume button. Avoid pausing the scan while the scanner is scanning a target such as a checkerboard. Pausing and resuming a scan directly on a target can cause automatic-target detection to fail for that target. Remember that it is essential for the scanner to remain absolutely motionless when paused, and we recommend pausing it using the Stream app or a connected browser, rather than tapping the scanner's screen.

To stop a scan, tap **Stop Scan** in the scanning view. You are then asked whether to keep or delete the incomplete scan.

---

**NOTE:** After scanning and picture capturing is complete, depending on environmental conditions, the scanner may make another turn to capture inclination data. *Do NOT move the scanner* while it is capturing the inclination data, or the inclination data of the scan might be inaccurate and usable for the scan registration.

---

As soon as the entire scanning process is complete, the scanner plays a notification sound, if not disabled in the settings, and a new screen appears with a preview picture of the captured scan. Now, you can move the scanner to the next scan position and start a new scan.

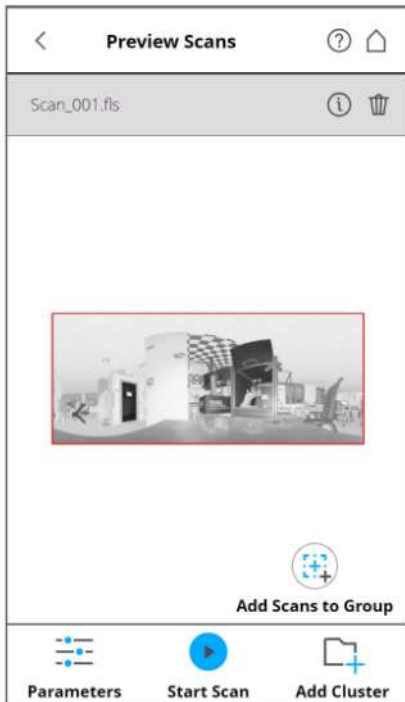




Figure 5-24 Scan Preview

The scan preview shows a gray-scale picture of the captured scan to verify the scan itself, and check if all objects (e.g., targets) are clearly visible. The preview may also contain detail scans belonging to the same scan group. See [Scan Groups on page 116](#)

**Parameters** -  Tap to change the scanning parameters for future scans.

**Start Scan**  Start a scan.

Tap **Info**  in the pop-up dialog of a selected detail scan to view the scan properties.

Tap **Delete**  to delete the displayed scan. In case of scan groups, only the primary scan, as named in the title, is deleted. Embedded detail scans are not affected.

Tap **Delete** in the pop-up of detail scans to delete the selected detail scan.

**Add Scans to Group** (  ) See [Scan Groups on page 116](#)

Use pinch gestures to zoom into the preview image.

When zoomed in, move the zoomed picture by dragging it with your fingers or the mouse in any direction.

The **Inclination** in degrees is displayed in the header bar. The following inclination warning message is displayed if the current inclination of the scanner is above 5°.

## Strong Scanner Inclination

Inclination of the scanner is not within +/- 5°. This could result in slightly inexact scan measurements.

Try to position the scanner so that its inclination is between +/-5°. To get reliable measurements from the built-in dual-axis compensator, set-up the scanner with an inclination of less than 5° before starting the next scan. To do this, use either a bubble level at the tripod or the inclinometer screen.

## LED Behavior

LED at Power ON/OFF button	LED Color
Scanner off, external power supply not connected	Off
Regular boot process	Flashes blue quickly
Battery operation	Constantly blue
Power turning on or off	Flashes blue
Laser is in operation	Red blinking

LED in battery compartment or Power Dock no power supply connected	LED in battery compartment or Power Dock with power supply & charging	Charge in %
Violet	Violet blinking	5% - 15%
Red	Red blinking	5% - 15%
Orange	Orange blinking	15% - 25%
Yellow	Yellow blinking	25% - 95%
Green	Green blinking	>95%
Green	Green	~100% (fully charged)
n/a	White	No battery
n/a	Cyan blinking	error/error flag

## Data Security

Scans are hashed and cryptographically signed to make detection of whether the recorded scan data has been modified possible. The hash value of a scan can be manually checked on the scanner GUIs *Scan Properties* page. In addition, the hash and signature of a scan can be verified with the Scan Verification Tool that is available on FARO's Knowledge Base ([knowledge.faro.com/Hardware/3D\\_Scanners/Focus/Scan\\_Verification\\_Tool\\_Download\\_and\\_Manual](http://knowledge.faro.com/Hardware/3D_Scanners/Focus/Scan_Verification_Tool_Download_and_Manual)).

## Shutting Down the FARO Focus Premium

To shut down the FARO Focus Premium, press the **Power On/Off** button *for about 3 seconds* or tap the **Power** button in the user interface drop-down list on the home screen. Confirm your intent to shut-down the scanner by tapping in the dialog box on the screen. The top LED then starts blinking blue. As soon as the FARO Focus Premium has finished shutting down, the LEDs stop blinking. You can then safely remove the battery and the power-supply.

---

**NOTICE: Damage to the scanner's internal PC and data loss.**

Do not turn-off the power to the FARO Focus Premium before the shut-down cycle is complete.

The FARO Focus Premium has an integrated PC. This internal PC must be shut-down before turning off the power-supply. If the power-supply is disconnected or switched off without the FARO Focus Premium being previously shut-down, it can damage the internal PC and might lead to a data loss.

If the FARO Focus Premium has not been properly shut down, the next boot process might require more time than usual, because the FARO Focus Premium may need to check for errors.

---

Pressing and holding for more than 10 seconds switches the FARO Focus Premium off without properly shutting it down. Use this option only if the FARO Focus Premium will not shut down, such as due to malfunction. Never remove the battery in case the scanner is unresponsive. Always use the above mentioned method and press the top button until the scanner shuts down.

## Powering Off the FARO Focus Premium

Once the FARO Focus Premium has been completely shut-down, remove the battery and secure the equipment in protective cases.

1. To remove the battery:
2. Open the battery compartment cover.
3. Release the interlock mechanism of the battery.
4. Remove the battery.
5. Close the battery compartment cover.

## Chapter 6: Controller Software

### General Elements







#### Status Bar





Figure 6-1 Status Bar

- ① **Inclinometer** shortcut and status icon. The icon turns red if scanner is not leveled accurately. This icon is updated at a low rate.
- ② **Clock** - Shows the current time. See [Setting the Date and Time on page 37](#) for information on how to change the date and time of the scanner .
- ③ **WLAN** Shows the status and the signal strength.









④ SSD and SD card status

	90% of the SSD is full. Delete old projects or backup on the SD card or to the cloud.
	80% of the SSD is full. Delete old projects or backup on the SD card or to the cloud.
	SD card is busy. Do not remove the SD card from the scanner while it is busy, otherwise you risk corrupting the data on the card.
	No SD card inserted.
	SD card is write-protected. Remove write protection to scan using this card.
	Unknown SD card inserted. The card cannot be read. This might be due to the SD card being formatted in an unsupported file system. You should format the SD card with the scanner's format function. See <a href="#">Service on page 98</a> .

⑤ GPS Signal

	GPS signal available
	No GPS signal, or vague position

⑥ **Battery** - Shows the status and charge-state of the internal battery

	Battery is fully charged
	Charge state > 75% and < 100%
	Charge state > 50% and < 75%
	Charge state > 25% and < 50%
	Charge state > 10% and < 25%, you should change the battery as soon as possible.
	Battery is almost empty; the scanner will automatically shut down within a few minutes.
	Battery is charging.
	No battery in the scanner.

The exact charge-state of the battery can be viewed under **Home Screen** >  **Manage** > **General Settings** > **Power Management** (see [Power Management on page 87](#)).

If the charge state of the battery is below circa 15%, you get a warning. Switch to the spare battery as soon as possible.

If the charge state of the battery reaches circa 10%, the scanner stops scanning and automatically shuts down. (If you start a new scan if the battery has less than 15% charge you may not be able to finish the scan.)

⑦ **Battery Charge Percent** - Shows the exact amount of power remaining in the battery as a percentage.

## Scanner Menu Map

*Italic text* indicates a reported value (such as scan duration, or serial number) that cannot be changed by the user.



### Parameters

#### Parameters > **Selected Profile**

- Accelerated
- Standard
- Extended
- Object HD

#### Parameters > **Resolution / Quality**

- Resolution
- Quality
- Scan Duration*
- Scan Size*
- MPts*
- Point Distance*
- Unambiguity Interval*

#### Parameters > **Horizontal / Vertical**

- Horizontal Area
- Vertical Area
- Default Area

#### Parameters > **Select Sensors**

- Use Inclinometer
- Use Compass
- Use Altimeter
- Use GPS
- Recommended Settings



**Parameters > Scan with Color**

**Parameters > Color Settings**

Internal Camera  
Even Weighted Metering  
Horizon Weighted Metering  
Zenith Weighted Metering  
High Resolution  
High Resolution  
HDR Mode  
Night Mode  
Speed Mode  
*Scan Duration*

Panorama Camera  
Number of Images  
Calibrate Panorama Camera

**Parameters > Advanced Setting**

Clear Contour  
Clear Sky  
Distance Range  
*Scan Duration*  
*Scan Size*  
*Scan File Size*



**Scans > Preview Scans**

Add Scans to Group



**Manage > Projects/Clusters**

Project Name  
Parent Project  
Customer  
File Base Name  
Initial Scan No.  
Additional Info  
Latitude

**Manage > Profiles**

- Accelerated
- Standard
- Extended
- Object HD
- Add
- Delete

**Manage > Operators**

- Name
- Company
- Department
- Phone
- Email
- Info

**Manage > Sensors > Temperature**

- Fan Cooling
- Current scanner temperature*

**Manage > Sensors > Inclinometer**

- Use Inclinometer
- Inclinometer warnings

**Manage > Sensors > Compass**

- Use Compass
- Update Compass

**Manage > Sensors > GPS**

- Use GPS

**Manage > Sensors > Altimeter**

- Use Altimeter
- Reference Height
- Sync Altimeter

**Manage > General Settings > Sounds**

- Volume
- Sound during scanning
- Sound when scan is finished
- Sound when warnings are issued
- Sound when errors are issued

**Manage > General Settings > Power Management**

Dim Display during Scanning  
Start on Power  
*Current Power Supply*  
*Battery Charge State*

**Manage > General Settings > Display**

Brightness  
Select Theme  
    Dark  
    Bright  
  
Display orientation  
    Normal  
    Landscape left  
    Upside down  
    Landscape right

**Manage > General Settings > WLAN**

Status  
Mode  
    WLAN  
    Access Mode  
  
*Network Name*  
Regulatory Domain  
WLAN Channel  
IP Address  
Security  
Encryption Key  
*Port*  
*MAC Address*

**Manage > General Settings > LAN**

Status  
IP settings  
    DHCP  
    Static  
  
Proxy Settings  
No Proxy  
Manual

**Manage > General Settings > Date and Time**

Automatic date and time  
24-Hour Clock  
Select Date Format  
Select time zone  
Change Date and Time

**Manage > General Settings > Language**

(Various languages are available.)

**Manage > General Settings > Units**

Meters / Feet

Celsius / Fahrenheit

Decimal Degree Notation / Degree-Minute-Second Notation

**Manage > General Settings > Scanner Details**

Scanner Name

Manager Feature Licenses

Owner

*Serial Number*

*Model*

*Scanner Revision*

*Total No. of Scans*

*Firmware Revision*

*System Revision*

Regulatory information

*FCC ID*

*IC ID*

**Manage > General Settings > Allow Retaking Pictures**

**Manage > On Site Registration**

Enable Processing

No Registration

Target Based

Top View Based

Cloud to Cloud

Top View Based + Cloud to Cloud

IP Address

Port

**Manage > Swift Details** (only available with a Swift license)

Mobile scan resolution

Anchor scan duration

Enable Swift color

---

**NOTE:** Refer to the Swift User Manual for more information about Swift, available here:  
[https://knowledge.faro.com/Hardware/3D\\_Scanners/Swift/User\\_Manual\\_for\\_the\\_Swift](https://knowledge.faro.com/Hardware/3D_Scanners/Swift/User_Manual_for_the_Swift)

---

**Manage > Service**

Notifications

Internal Mass Storage

SD Card

Format

Log File

Size of Log File

First Log Message

Last Log Message

Backup

Backup Name

Operators

Profiles

Parameters

Restore

Auto Backup

Firmware Update

Fast Installation

Factory Settings

Reset

Customer Support

*for United States and Canada*

*for Mexico*

*for Europe and EMEA*

*for Singapore*

*for Shanghai*

*for Japan*

*for India*

*for South Korea*

Command Prompt

Command Line

*Last Service Date*

**Manage > Storage Management**

Scan Storage (Internal, SD Card)

Delete

Export (to SD Card)






## Navigation Bar



Figure 6-2 Navigation Bar

- ① **Back** - Returns you to the previous screen.
- ② **Screen Name** - Name of the screen that is currently shown.
- ③ **Errors and Warnings** - Only appears, if warning or errors are present. Tap this to open a screen that shows the details of the existing warnings or errors. See [Service on page 98](#).
- ④ **Help** - Opens the online help of the currently active screen, providing access to the user manual. See [Online Help and Notifications on page 103](#).
- ⑤ **Home** - Returns you to the home screen. See [Frequently Used Buttons below](#).

## Frequently Used Buttons

	Add new scan profiles, projects, or operators.
	Duplicates the selected list element, and adds it as a new scan profile, project, or operator.
	Deletes selected list elements, such as projects, scan profiles, or operators. This is grayed-out, if the selected list element cannot be deleted.
	Opens a new screen with further details or settings.
	Turns functions on or off. Here, the function is turned on.

## Home Screen



Figure 6-3 Home Screen

- ① **Scan Mode** - Tap or swipe to switch between on-site-registration, standard, and Swift<sup>1</sup> modes.
- ② **Start Scan** - Starts a scan. See [Starting a Scan on page 49](#).

---

<sup>1</sup>Swift requires a separate license.

- ③ **View Scans** - Preview the scans stored on the selected storage medium. See [View Scans on page 102](#).
- ④ **Parameters** - Opens the dialog for scan profile selection, or to edit the current scanning parameters. See [Setting the Scanning Parameters on page 40](#).
- ⑤ **Info box** - Tap the arrow underneath **HOME** to show or hide the info box. The info box shows information regarding the currently selected operator, project, and scan profile, as well as regarding the current scanning parameters resolution in megapoints, its quality, scan duration, and color.

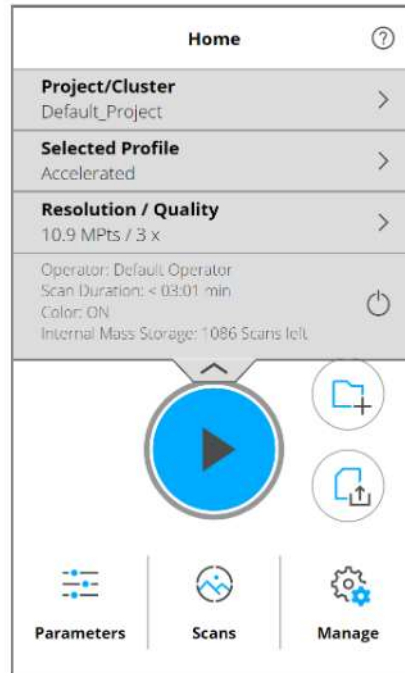


Figure 6-4 Home Screen with Info Box

- ⑥ **Add cluster** - Add a cluster to the currently selected project.
- ⑦ **Copy** - Copy the currently selected project and scans from the solid state drive (SSD) to the SD card.
- ⑧ **Manage** - Manage scan profiles, projects, operators, and the scanner. See [Manage on page 70](#).



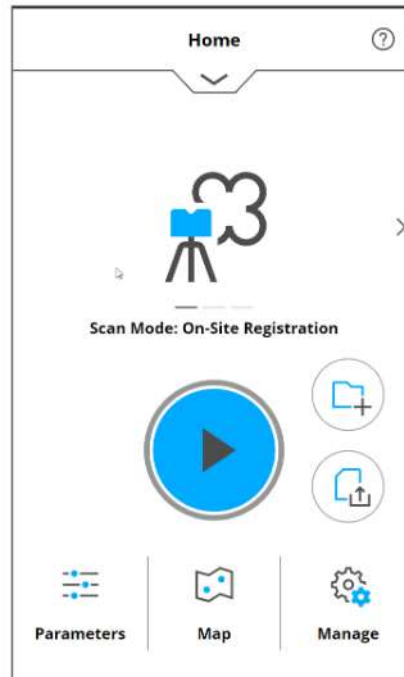



Figure 6-5 On-Site Registration home screen

## Scan Parameters

Scanning parameters, like resolution, quality, and scanning angles, are used by the scanner for recording the scan data.

There are two ways to set the scanning parameters:

- manually change them.
- selecting a scan profile, which is a predefined set of scanning parameters.

To select a predefined scan profile or to change the scanning parameters, tap **Parameters**  on the Home screen.

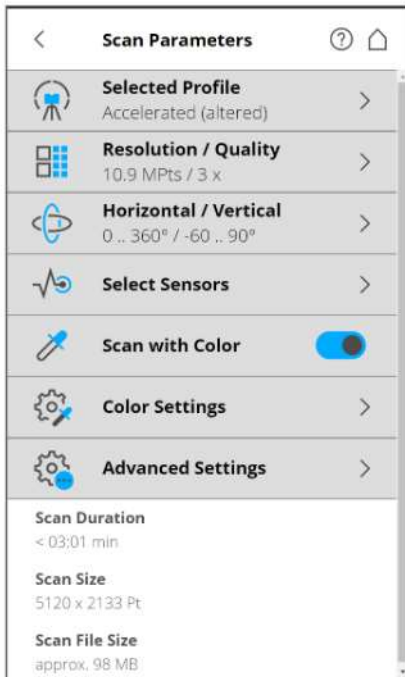


Figure 6-6 Change the Scan Parameters

## Selected Profile

Shows the name of the selected scan profile. Tap to select a scan profile. If the scanning parameters differ from the selected profile, **altered** is appended to the name.

---

**NOTICE:** Selecting a predefined scan profile overwrites all current scanning parameters with the settings of the selected scan profile.

---

## Resolution / Quality

Parameters > Resolution / Quality



Figure 6-7 Scan Parameters, Resolution, and Quality

Displays the selected resolution in megapoints and the selected quality. Tap to change these values.

## Horizontal and Vertical Scan Range

Parameters > Horizontal / Vertical

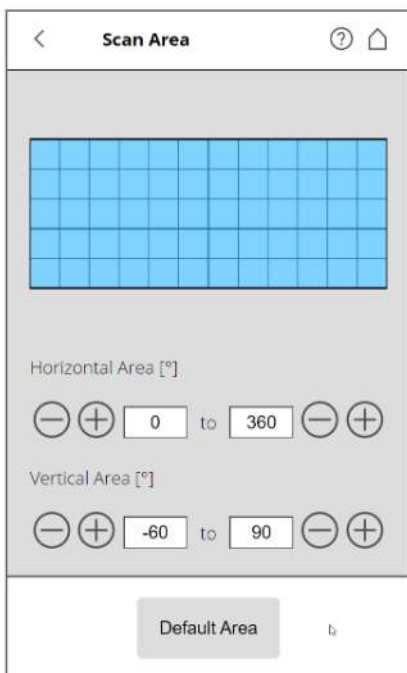


Figure 6-8 Scan Parameters - Scan Area

Displays the scan range with the horizontal and vertical start and end angles in degrees. Tap to adjust them.

## Select Sensors

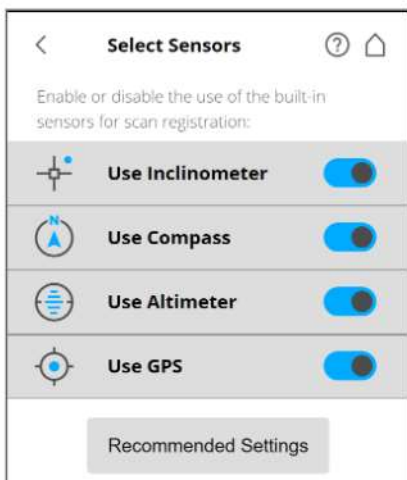


Figure 6-9 Scan Parameters - Select sensors

Opens the screen to enable or disable automatic use of the built-in sensors' data for scan registration in SCENE or Sphere.

## Scan with Color

Switches colored scan recording on or off. If switched on, the scanner also takes color photos of the scanned environment with the integrated color camera, or PanoCam, an additional accessory. (For more details about PanoCam refer to the [Accessories Manual for the Focus Laser Scanner](#).) These photos are taken immediately after the laser scan, and are used in the point cloud processing software SCENE or Sphere to automatically colorize the recorded scan data.

## Manage

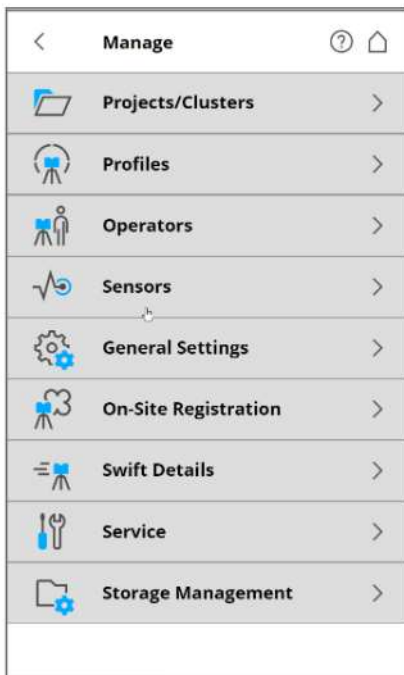


Figure 6-10 Manage

### Projects/Clusters

Selects the current scan project; creates a new, or edits an existing, project. Tap to get a list of all available projects. See [Scan Projects and Clusters on the next page](#).

### Profiles

Selects the current scan profile; creates a new, or edits an existing, scan profile. See [Selected Profile on page 76](#).

### Operators

Selects the current scanner operator; creates a new, or edits an existing operator. See [Operators on page 78](#).

### Sensors

Opens the menu for sensor settings . See [Sensors on page 80](#).

### General Settings

Opens the menu for the general scanner settings. See [General Settings on page 86](#).

### On-Site Registration

See [On-Site Registration on page 97](#).

### Swift Details

See [FARO Swift User Manual](#) for information about Swift.

### Service

Opens the menu for scanner services, such as firmware updates, backups, or viewing errors and warnings. See [On-Site Registration on page 97](#).

## Scan Projects and Clusters

The Projects/Clusters page displays the structure of your scan projects. A scan project usually consists of a main project that has several sub-projects called clusters. For example, if you are scanning a multi-level building as a project, each floor of this building might represent one cluster, and each of these floors or clusters can have further clusters, for rooms.

The structure of a scan project is similar to this:

- Office building
  - Floor 1
    - Room 1
    - Room 2
    - Room 3
  - Floor 2
    - Room 1
    - Room 2

Before starting a scan project, you can manually enter this structure here. You can reconstruct the complete structure of your scan project within the scanner software.

Once the project structure has been created, assign the single scans to the corresponding clusters. To do this, select a scan project and cluster before starting a scan. This project should correspond to the current scanner position. For example, if you take scans in the office building on Floor 2, in Room 2, select *room 2* from the project list, then start taking the scans in that room. The next scans are then assigned to the selected project or sub-project *room 2* until you select another cluster. This information is attached to

each scan. It helps SCENE or Sphere automatically assign scans to scan clusters, thus automating the scan registration. For more information on scan registration and assigning scans to scan clusters, see the SCENE user manual.

---

**NOTE:** Every project and cluster receives a unique internal identification number upon creation. Assigning the scans to scan clusters during post-processing in SCENE is done according to this identification number, not on the basis of the project name. This is particularly relevant when working with several scanners on the same scan project. In this case, you must set the storage on all scanners to the SD card, then create the project structure once as a master, and transfer it to all of your scanners. Thus, we do not recommend creating or editing a project of the same scan project separately on each scanner. Even if the separately created projects and clusters have the same name, they receive different identification numbers and are treated as different projects by SCENE.

---

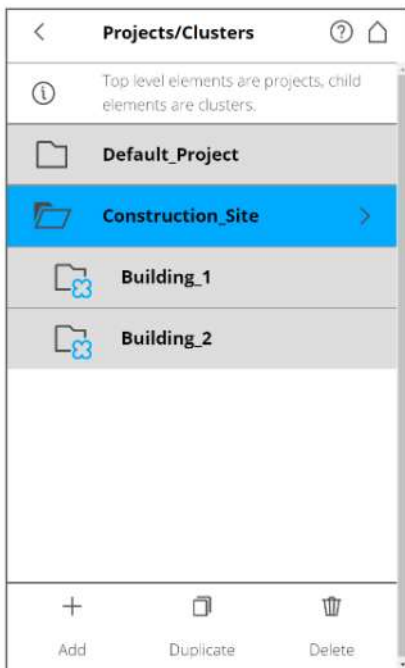


Figure 6-11 Projects List

This view shows a list of all created scan projects/clusters.

The *Default\_Project* is a standard project used, when not working in a particular scan project. The *Default\_Project* cannot be deleted, and the name of the project, as well as the parent project, cannot be changed.

## Add a Scan Project or Cluster

### **Manage > Projects/Clusters > Default Project**

To add a project, tap + at the bottom of the projects list. A new sub-project called *Default\_Project.1* is added to the selected project. Tap the field to open its parameters. This opens the View Project/Cluster menu.

Change the name, and enter further details for the new project. To make the new project the main project without any parent projects, you must either change its parent project to *No Parent Project*, or select the *Default\_Project* before adding the new project. With the *Default\_Project* selected, new projects are added as the main project without parent projects.

#### **Project Name**

Tap to change the name. A name must start with a letter and may contain letters, digits, and underscores.

#### **Parent Project**

The parent project of the displayed item. *No Parent Project* means that the current item is a project and not a cluster. Tap to change the parent project or parent cluster. A new screen appears with a list of all available parent projects or parent clusters. Select the parent project/cluster from this list. The currently edited item is then be assigned as a cluster to this project/cluster.

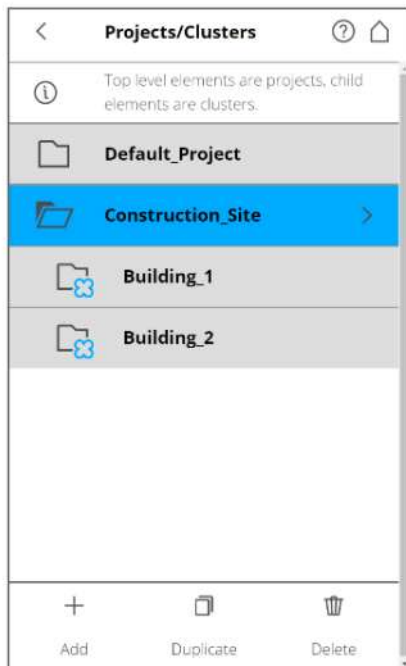


Figure 6-12 Select Parent Project/Cluster

Shows all available projects and clusters eligible to be a parent project/cluster. Tap to select the parent project/cluster. The selected parent project/cluster is highlighted.

#### **No Parent Project**



Tap, if the project should not have a parent project.

## Project Information

### Customer

If you are carrying out the scan project for a customer, you can enter the customer's name here.

### File Base Name

The scan is saved with a file name consisting of this base name, followed by the current scan number.

### Initial Scan No.

This automatically increments with each successive scan. It can be reset and can be used to indicate the number of scans per scan session. (If a scan with identical scan number and name already exists, the scan number will be automatically incremented to the next unused number.)


### Additional Info

Additional project information.

### Latitude [°]

Enter the approximate (+/- 10° is sufficient) latitude position of the scan project in decimal degree notation. This information helps to improve the accuracy of the inclination sensor, and leads to better scan registration results.

## Duplicate a Scan Project

Instead of adding a new, blank project or cluster, you can create new projects by duplicating existing ones. To do so, select the project to be duplicated, then tap **Duplicate**  at the bottom of the list. The newly created project has the same settings and properties as the original project.

## Delete a Scan Project

Select the project to be deleted in the list and tap **Delete**. If the project or cluster has subordinates, they are also deleted.

## How Scan Projects Are Saved

Scan projects are stored on the SSD or SD card depending on the settings in storage management. Projects stored on the SSD can be exported to the SD card.

## Editing a Scan Project

To edit a scan project, select it in the list, then tap it again to reach to its details view.

## Selecting a Scan Project

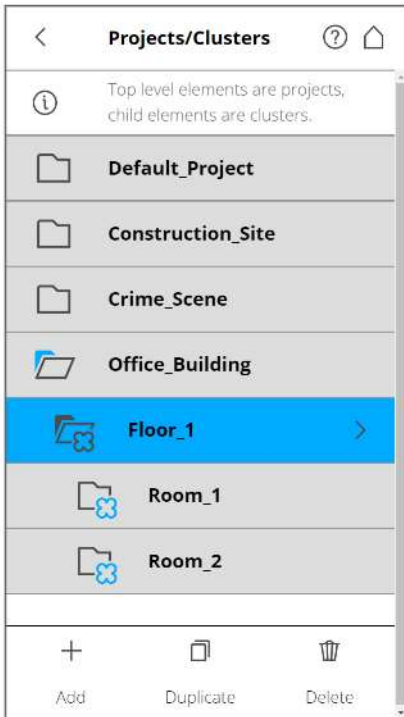


Figure 6-13 Project List




The project list contains the currently selected project, plus all other projects stored on the SSD or SD card.

To select a project, tap it in the list. The selected project is highlighted. To view or change details of the selected project, tap it once more.

To display available clusters of a project, select it to expand the list.

If the list of projects exceeds the screen size, scroll up or down with the scroll buttons at the bottom.

## Description of Project Button Icons

	Project
	Project has clusters that are currently shown (list is expanded accordingly)
	Cluster

## Selected Profile

### Parameters > Selected Profile

Selecting scan profiles to use their parameters for the next scan has already been described in [Setting the Scanning Parameters on page 40](#). This chapter will describe how to add new and how to edit existing scan profiles.

The **Profiles** page displays a context sensitive toolbar at the bottom to add, duplicate, delete, or modify profiles.

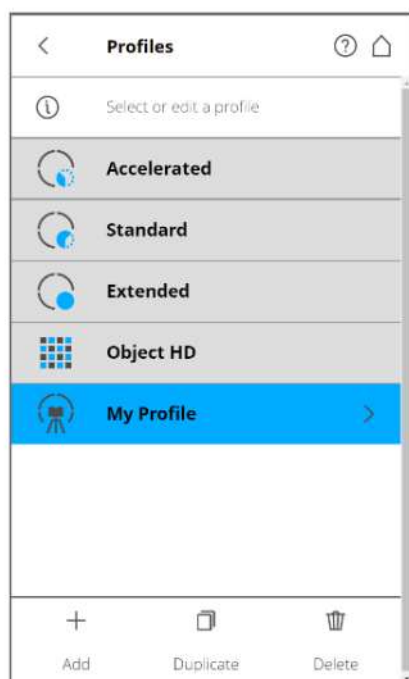


Figure 6-14 Profiles

## Description of Factory Profiles

	<b>Accelerated</b>	<b>Standard</b>	<b>Extended</b>	<b>Object HD</b>
<b>Remark</b>	Accelerated scan with main objects of interests at a short distance.	Standard scan with main objects of interests at a medium distance.	Extended scan with main objects of interests at a larger distance.	Object scan where the details of objects are of interest.
<b>Scan Resolution</b>	1/8	1/5	1/4	1/2
<b>Quality</b>	3x	3x	3x	4x
<b>Vertical area</b>	-60° to 90°	-60° to 90°	-60° to 90°	-60° to 90°
<b>Horizontal area</b>	0° to 360°	0° to 360°	0° to 360°	0° to 360°
<b>Inclinometer</b>	ON	ON	ON	ON
<b>Compass</b>	ON	ON	ON	ON
<b>Altimeter</b>	ON	ON	ON	ON
<b>Use GPS</b>	ON	ON	ON	ON
<b>Color</b>	OFF	OFF	OFF	ON
<b>Clear Contour</b>	ON	ON	ON	ON
<b>Clear Sky</b>	ON	ON	ON	ON
<b>Distance Range</b>	Near	Normal	Normal	Near
<b>Resolution [MPts]</b>	10.9	28	43.7	174.8
<b>Duration<sup>1</sup> [sec]</b>	59	99	137	969
<b>Point Distance [mm @ 10 m]</b>	12	8	6	3
<b>Scan File Size<sup>2</sup> (MB)</b>	41	98	138	538
<b>Scan Size (Pt)</b>	5120 x 2133	8192 x 3413	10240 x 4267	20480 x 8533

As previously mentioned, the FARO Focus Premium comes with factory-predefined scan profiles (see [Service on page 98](#) for an overview of the available factory predefined scan profiles). These scan profiles are read-only, and thus cannot be changed or deleted, but you can add and manage your own custom scan profiles based on these pre-defined profiles.

This view shows all scan profiles that are available on the scanner.

<sup>1</sup>Times can vary depending on color capture settings and the objects being scanned.

<sup>2</sup>With standard 8 MPx images.

To add a new profile, tap **Add**. You can also add new profiles by duplicating existing profiles. To do this, select the profile that you want to duplicate and tap **Duplicate**. Tap again on the profile. A new screen appears. Enter the profile name, and adjust its scan parameters.

To delete a custom scan profile, select it and tap the **Delete** button. You cannot delete factory predefined profiles.

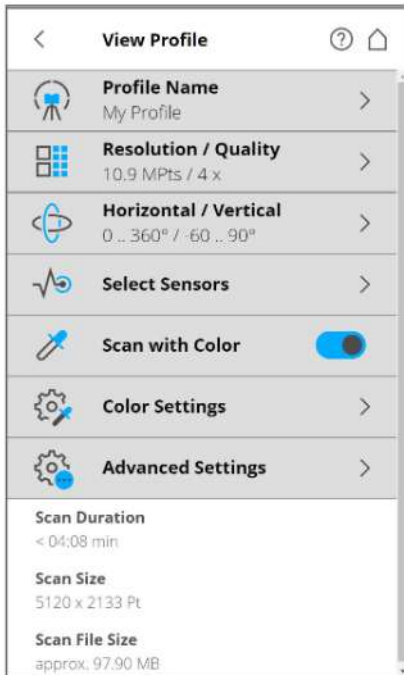


Figure 6-15 Scan Profile Details

**Profile Name** - Name of the scan profile. Tap to change it.

The further settings in this view are similar to the settings of the scanning parameters. See [Scan Parameters](#) on page 66.

## Editing a Scan Profile

To edit a scan profile, select it in the list and tap it again to view its details. You cannot edit predefined profiles, but you can duplicate them and edit the copy.

To view the details of the selected profile, tap it again.

## Operators

### Manage > Operators > Default Operator

Information about which scanner operator has recorded which scans can be useful for the person who is post-processing the scans, especially when there are several scanner operators working on the same scan project.

You can assign scanner operators to the captured scans. To do this, select the operator in the operators list. Create an operator profile, if it does not already exist. The information regarding the selected operator is stored in the data of the next scans, and can be accessed in SCENE during the post-processing of scans.

## Creating an Operator Profile



Figure 6-16 Operator Profiles list

To add a new operator profile, tap **Add**. You can also add new operator profiles by duplicating an existing operator profile. To do this, select the operator profile you want to duplicate and tap **Duplicate**. Tap again to view a screen, and enter the operator profile details.

To delete an operator profile, select it and tap **Delete**.

Operator Profile details include the following:

**Name** - The name of the scanner operator.

**Company** - The name of the company providing the scanning service.

**Department** - The department the operator works for.

**Phone** - The operator's phone number.

**Email** - The operator's email address.

**Info** - Any additional information required by the service provider or shift leaders, project managers, etc.


## Editing an Operator Profile

To edit an operator profile, select it in the list and tap it once again to find its details.

## Selecting an Operator Profile

Select an operator profile in the list by tapping the corresponding button. The selected operator profile is highlighted, and assigned to the captured scans, until another operator profile is selected. To view or edit the details of the selected operator profile, tap it again.

## Sensors

 **Manage > Sensors > Temperature**

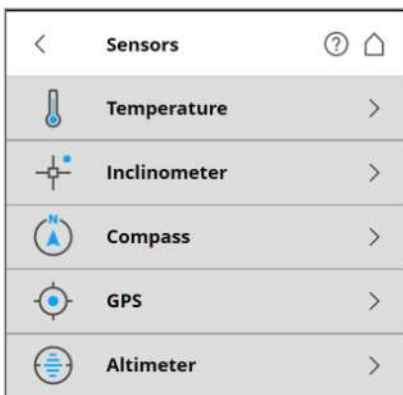


Figure 6-17 Sensors

**Temperature** - Tap to view the current scanner temperature and to switch the scanner's fan on or off. See [Temperature Sensors](#) below.

**Inclinometer** - Tap to level the scanner. See [Inclinometer \(Dual-Axis Compensator\)](#) on the next page.

**Compass** - Tap to view the orientation of the scanner. See [Compass](#) on page 83.

**GPS** - Tap to view details regarding the current GPS position and accuracy. See [GPS](#) on page 84.

**Altimeter** - Tap to view the currently measured altitude of the scanner's position and to sync the altimeter with a reference height. See [Altimeter](#) on page 85.

## Temperature Sensors

The scanner has several integrated temperature sensors that measure the temperature at different points inside the scanner. This screen shows the temperature of the sensor with the currently most critical value.

If a sensor is outside of the recommended operating temperature, but not yet critical, the temperature display is highlighted in yellow. Scanning is still possible, but we recommend letting the scanner either warm up or cool down until the temperature display is again highlighted in green.

If the temperature is too high or too low, the temperature display is highlighted in red. In that case, scanning is not possible. The scanner shuts down within a few minutes.

**Fan cooling** switches the scanner's integrated fan on or off.

If the temperature is above the critical limit, ensure that the fan is switched on. If not, switch it on.


---

**NOTICE: Switch the fan off in exceptional cases only!**

If the fan is switched off for long periods, the scanner can overheat, resulting in an aborted scanning process or causing damaged.

---

## Inclinometer (Dual-Axis Compensator)

 **Manage > Sensors > Inclinometer**

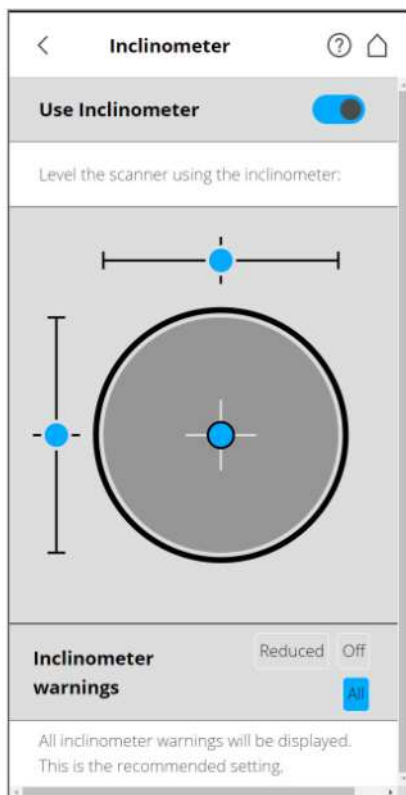


Figure 6-18 Inclinometer

### **Level the Scanner Using Inclinometer**

The view displays a bulls-eye bubble level inclinometer, as if it were mounted on top of the scanner. If the background color is gray, the inclinometer is leveled within 2 degrees. The background color of the



inclinometer turns yellow, if the scanner is tilted more than 2°. In this case, the accuracy of the inclination measurement is reduced.

If the inclination is larger than 5°, the background color of the level will turn red. This has two consequences:

- The inclinometer accuracy is further reduced
- The scan quality may be affected.

The two linear levels describe the direction of inclination: If the bubble in the upper level is on the left side, the scanner is tilted to the right, if you are standing in front of the display. If the scanner is tilted towards you, the bubble in the left level is in the upper half.



---

**NOTE:** The inclinometer needs to know the latitude of the scanner to compensate for natural variations in the earth's gravitational field. Without this information, scans in a project may have an incorrect inclination, which can increase registration errors.

If you use the inclinometer, ensure that you set the latitude for the project. See [Latitude \[°\]](#) on [page 74](#).

---

### **Inclinometer Warnings**

The Inclination Warning icon in the header bar is only visible, when the current inclination of the scanner is above 2°, in which case it is yellow . The icon becomes red , if the scanner is tilted more than 5°. Note that these icons are updated less frequently than the bubble level icon.

To get reliable measurements from the built-in dual-axis compensator, you must set up the scanner with an inclination less than 5° before starting your next scan. Note that inclinations greater than 2° are measured with less precision, which can affect the scan registration. To align the scanner, you can use either a bubble level at the tripod or the inclinometer screen.

The displayed warnings can be configured as follows:

#### **All**

An inclinometer warning is displayed, if the scanner is tilted more than 2°. This is the recommended setting.

#### **Reduced**

An inclinometer warning is displayed, if the scanner is tilted more than 5°.

#### **Off**

No inclinometer warnings is displayed in the header bar. (Not recommended.)

## Compass

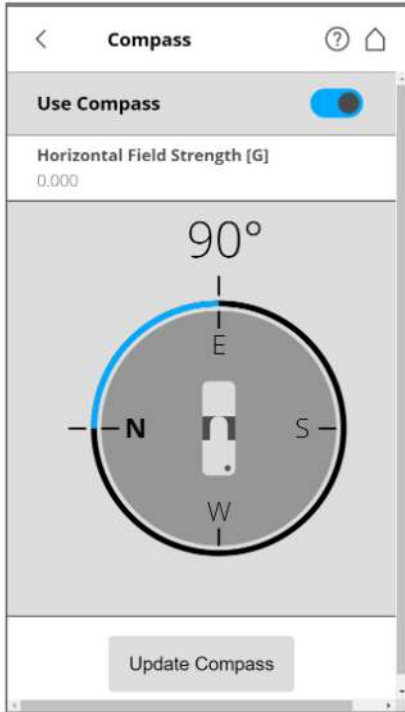


Figure 6-19 Compass

The built-in electronic compass measures the orientation of the scanner on the earth's surface. This information is useful for the registration process.

It is attached to each scan and can be used for the scan registration in SCENE. See the SCENE user manual for more information.

If you want SCENE to use the compass data for the scan registration, switch the **Use Compass** function to ON. Otherwise, switch it to OFF. This setting affects the current scanning parameters, and has the same function as the equivalent button in the parameters settings. See [Setting the Scanning Parameters on page 40](#).

You can monitor the current orientation of the scanner on this screen. Initially, when entering this screen, the orientation is not displayed. To see the current orientation of the scanner, tap the **Update Compass** button on the bottom. For the measurement, the scanner needs to turn horizontally by 360°. Ensure that the scanner can move freely, and do not move the scanner during the measurement.

As soon as the scanner has completed the rotation and determined its orientation, a compass is displayed as if it were mounted on top of the scanner. This compass illustrates the current scanner orientation. Additionally, the measured orientation value is displayed in degrees.

To get updated orientation data, for example, if the scanner has been moved to another position, tap **Update Compass** again.

This manual compass measurement only affects the output on this screen. It is not necessary for the orientation data measured during scanning. During scanning, an orientation measurement is automatically performed.

The accuracy of compass measurements can be affected by environmental interference, such as magnetic interference. An indicator of the strength of environmental interference, and thus of the current compass measurement accuracy, is the displayed **Horizontal field strength** of the magnetic field. The typical strength of the earth's magnetic field depends on geographical position and varies from 0.3 to 0.6 gauss (G). The displayed horizontal field strength is lower than the absolute field strength because of the inclination of the field. For example, the typical horizontal field strength for Europe is about 0.2 gauss.

If the measured field strength differs significantly from the expected field strength, there might be a strong, artificial magnetic field near the scanner that is affecting the measurement. To get the most reliable orientation data for the scan registration, avoid positioning the scanner near strong magnetic fields. If the measured horizontal field still significantly differs, switch the compass data to OFF.

---

**NOTE:** Ferromagnetic objects (such as radiators and steel pillars) and electromagnetic fields (e.g., from electrical cabinets or controller units) can disturb the earth magnetic field. This, as well as local variations in earth magnetic field (magnetic declination/variation) can lead to inaccurate compass measurements. In this case it's recommended to switch off the use of the compass data.

---

## GPS

The scanner's position information provided by the built-in GPS sensor is attached to each scan, and is used for the scan registration in SCENE, if the GPS sensor is switched ON.

**Use GPS** - Turn the GPS sensor ON or OFF. Unlike the other sensors, GPS data is only recorded and attached to each scan, if this sensor is turned ON. For more information, see [Setting the Scanning Parameters on page 40](#)

After the GPS sensor is switched ON, it begins searching for GPS satellites. Note that it can take a few minutes to find all available satellites, and to determine precise positional information. We recommended switching the GPS sensor OFF, if it is not needed or if a GPS signal is not available (e.g., if you are scanning indoors).

**GPS information** - Provides information about the currently measured GPS coordinates, including the latitude, longitude, and altitude, as well as the UTC time of the last satellite contact and the number of satellites that are currently in view. The GPS receiver needs the signal of at least three satellites to calculate a 2D position (latitude and longitude). With four or more satellites in view, the receiver can determine the scanner's 3D position (latitude, longitude, and altitude).

The signal strength bars below the GPS information appear for each satellite in view with the appropriate satellite number underneath. These indicate the signal strength for each satellite.

**GPS precision** - Provides information about the precision of the currently measured coordinates in meters or feet. The DOP (dilution of precision) values are an indicator of the current satellite constellation geometry's quality. In general, good position measurements can be achieved, when the satellites are located at wide angles relative to each other. In this case, the DOP values are low. Higher DOP values indicate a poor satellite geometry, which might have a negative effect on the position accuracy.

The current GPS status and signal quality is indicated by different GPS icons in the status bar of the operating software.

Before starting a scan, you should always look at the GPS icon and the indicated quality. If no GPS data is available or position deviation is high, try to find a position with better signal quality.

A limited GPS signal can have many different causes. As with portable navigation devices, make sure that the scanner always has an unobstructed view of the sky. Obstructions can block the signal reception, causing position inaccuracy or no position data. The GPS signal can also be reflected by objects (for example, buildings or mountains), causing the measured position to wander. The more satellites the sensor has in view, the better the fix is.

## Altimeter

The barometric height sensor (altimeter) determines the altitude of the current scanner position. The altitude determination is based on the measurement of the atmospheric pressure. The measured altitude is attached to each scan, and can be used for the scan registration in SCENE. See the SCENE user manual for more information. If you want SCENE to automatically use the measured altitude for the scan registration, switch the **Use Altimeter** to ON; else switch it to OFF. This setting affects the current scanning parameters, and has the same function as the equivalent button in the parameters settings. See [Setting the Scanning Parameters on page 40](#)

To see the currently measured altitude on this screen, the altimeter must be switched ON.

For scan registration, you need only know the difference in altitude of the various scanner positions. Before starting your scan project, you should pick a position for your scanning site that you would like to use as the reference for the altitude measurements. Move the scanner to this reference position, enter any height you would like to use for this position, then reset the altimeter to this reference height by tapping **Sync Reference Height**. All further altimeter measurements are then done based on this reference height.

If you want comparable height measurements across different projects, sync the altimeter with a real altitude. Pick a reference position of your scanning site, where you know the approximate altitude above sea level. You can get this value from a GPS, topographic map, or from Google Earth.

Since the altimeter determines the altitude based on the atmospheric pressure measurement, changes in air pressure caused by changing weather conditions effect the resulting altitude. To get precise altitude measurements, periodically check the reference altitude; at least at the beginning of each project day and when the weather changes. To do this, move the scanner back to your reference position, and compare the altitude reading with the reference height. If there is a difference, re-sync the altimeter with the reference height.

## General Settings

 **Manage > General Settings**



Figure 6-20 General Settings

**Sounds** - Change the volume of the scanner sounds. Enable or disable scanner sounds. See [Sounds on the next page](#)

**Power Management** - View detailed settings regarding the administration of power, such as the battery charge level. Enable or disable **Start on Power**, which causes the scanner to switch on when it is connected to a power supply. Modify display settings to optimize power usage. See [Power Management on the next page](#)

**Display** - Set the brightness of the screen or change the theme of the Home screen to **Dark** or **Bright**. See [Display on page 88](#)

**Date & Time** - Change the displayed time and date format, or change the date and time of the scanner. See [Setting the Date and Time on page 37](#).

**Language** - Change the language of the controller software. See [Setting the Interface Language on page 37](#).

**Units** - Change the unit used for length. See [Setting the Unit of Length and the Temperature Scale on page 38](#).

**Scanner Details** - View and change details of the scanner. See [Scanner Details on page 96](#)

**Allow Retaking Pictures** - Enable the ability to retake any pictures with the internal camera immediately after the scan completes. Note that when this option is enabled, you must take extra steps to close the scan. See [Retaking Pictures on page 119](#).

**Remote Access to Scans** Enabling this function gives you access to the scans on the inserted SD card on remote devices that are connected to the scanner through WLAN or Ethernet. For more information, see [WLAN on page 89](#)

#### **Risk of data loss**

---

**NOTICE:** Use only if you're about to access scan files through a network. If you have chosen the SD card as the storage medium, DO NOT remove the SD card until remote access is disabled.

The status of the SD card is set to busy as long as this function is enabled. Disable it before you remove the SD card from the scanner. Remote access is automatically disabled, when shutting down the scanner. You must re-enable it after reboot.

---

## Sounds

### **Manage > General Settings > Sounds**

The scanner has a built-in speaker. The scanner signals certain events with various sounds. You can change the speaker volume here, as well as switch the sound effects ON or OFF.

**Volume** - Increase or decrease the volume of the scanner sounds.

**Sound during scanning** - If switched on, the scanner plays a warning signal, when the laser is switched on and scanning starts.

**Sound when scan is finished** - If switched on, the scanner plays a sound when scanning is complete.

**Sounds when warnings are issued** - If switched on, the scanner produces a sound when a warning is issued.

**Sounds when errors are issued** - If switched on, the scanner produces a sound when an error is issued.

## Power Management


### **Manage > General Settings > Power Management**

**Dim display during scanning** - If switched on, the brightness of the screen decreases during scanning to save battery power. Switching this ON is particularly useful for long scans.

**Start on Power** - Enable the scanner to be turned on, if it was turned off, by connecting it to the external power-supply. This is useful for automation applications, for example, with the automation models of the scanner using the automation interface.

**Power supply info** - Provides information regarding the current power-supply source and the charge state of the battery.

## Display

 **Manage > General Settings > Display**

**Brightness** - Set the brightness of the screen.

**Select Theme** - Change the theme of the **Home** screen to **Dark** or **Bright**.

**Display orientation** - Set the orientation of the display as desired.

## WLAN

### Manage > General Settings > WLAN

The WLAN interface can be used for remote connections, especially if your scanner is not equipped with an Automation Interface connection.

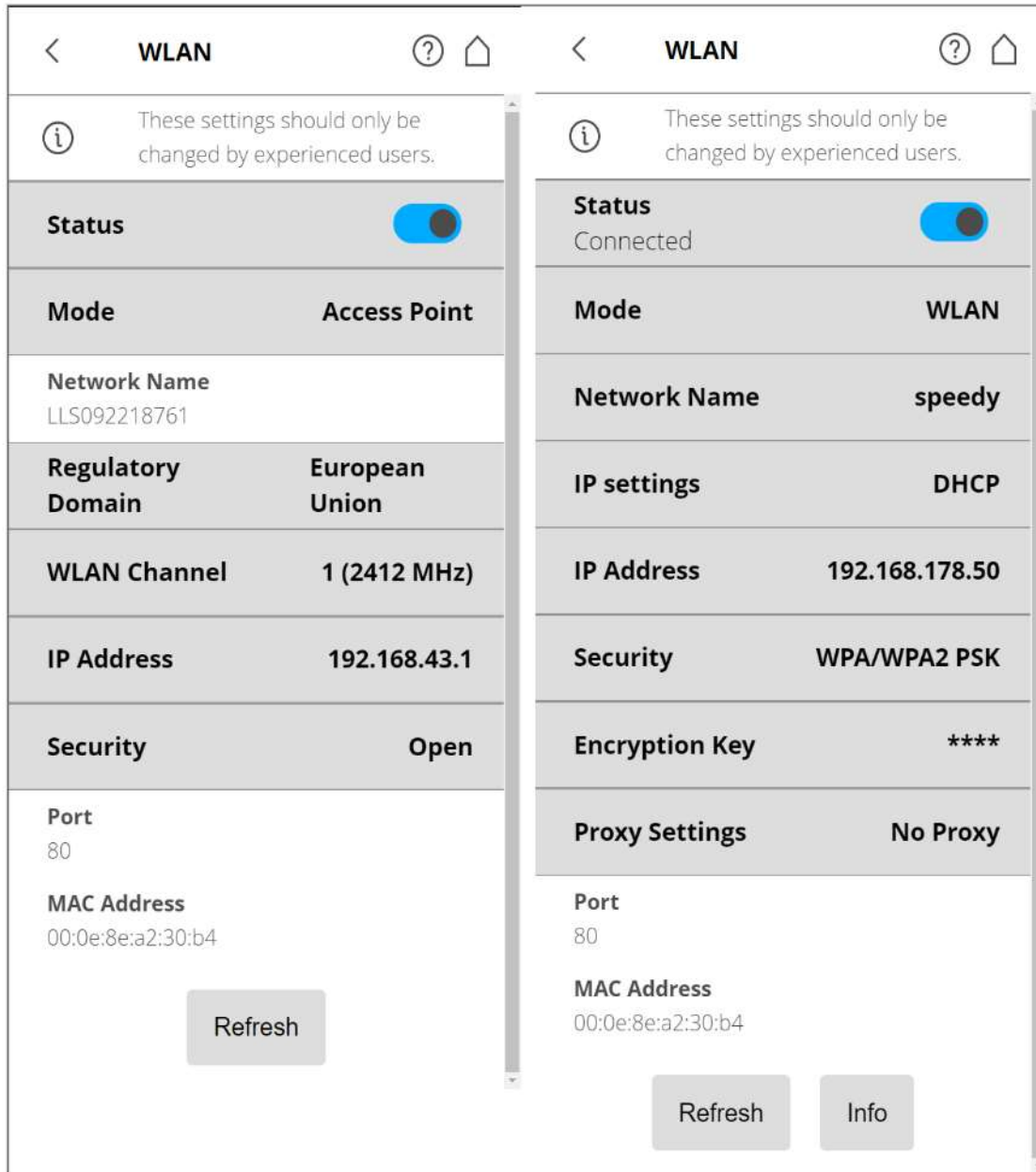


Figure 6-21 WLAN Settings

The scanner has an integrated WLAN module that remotely connects to the scanner with portable devices, such as notebooks, PDAs, or tablets. Connect your remote device to the scanner via WLAN, and



remotely access the scanner user interface with a standard web browser or the Stream app. The WLAN option also provides remote access to the scan files on the scanner's SSD or SD card.

It is possible to turn WLAN off from a remote interface. Since this might disable the connection to the remote interface, a warning is displayed.

---

**NOTE:** The scanner user-interface can be accessed through the following desktop browsers: Chrome, Mozilla Firefox, Safari, Opera, or Edge. The WLAN option also provides remote access to the scan files on the SSD or the inserted SD card if **Remote Access to Scans** is enabled on the General Settings page.

Mobile browsers: Android Chrome, Android Browser, and iOS Safari. WLAN settings can only be modified through the scanner user interface, and not with the remote interface.

Changes to the WLAN settings are only possible if WLAN is turned off.

---

## **Status**

Tap to turn this ON or OFF. Indicates whether WLAN is available. If WLAN is not needed, we recommend turning it off.

---

**NOTE:** Changes to the WLAN settings are only possible, if WLAN is turned off.

---

Two different WLAN operating modes are possible:

- **WLAN** - This setting is also known as infrastructure mode. The network is configured so that the scanner can connect to an external access point. Data transfer rates depend on the network and other WiFi traffic in your neighborhood.
- **Access Point** - The scanner network is configured as an access point.

## **WLAN Mode Scanner Settings**

### **Network Name**

The name of the wireless network. Tap it to enter a screen, where the available networks are displayed and can be selected.

### **IP Settings**

Set a static IP Address, or obtain one automatically through DHCP.

The IP settings determine whether an IP address is assigned by a server using DHCP or manually set (Static):

- **DHCP** This is the default/recommended setting.
- **Static** The IP address is manually assigned. The following settings must be provided.

## IP Address

The IP address of the scanner. A unique IP address must be preset on the WLAN network. If your remote device is connected to the scanner, enter this address into the address field of your web browser (for example, **http://172.17.16.23**) to access the controller software. Tap to change the scanner's IP address.

For secure, encrypted communication with the scanner GUI, enable the secure connection **https://172.17.16.23** in the address field of your web browser. You receive a security warning from the browser, before connecting to the GUI. Follow the instructions in your browser to complete the connection.



## Your connection is not private

Attackers might be trying to steal your information from **192.168.178.50** (for example, passwords, messages, or credit cards). [Learn more](#)

NET::ERR\_CERT\_AUTHORITY\_INVALID

💡 To get Chrome's highest level of security, [turn on enhanced protection](#)

Advanced

Back to safety

Figure 6-22 Scanner secure connection: Warning

Be aware that setting an IP address manually can result in a conflict if two devices on the same wireless network claim to have the same IP address.

Consider the following for a static IP connection:

**Gateway** - The gateway used to access the WLAN network.

**Network prefix length** - The subnet mask used in the WLAN network.

**DNS 1** - First dynamic name server to be used in the WLAN network.

**DNS 2** - Second dynamic name server to be used in the WLAN network.

**Security** - Choose the security protocol to be used by the access point to which the scanner connects:

- **Open** - Connect to an open network that can be accessed by anyone without a password. The information exchange is not secured.
- **WEP** - Connect to a network that is secured by WEP. This option requires an encryption key with 8 to 63 characters. This security level is not secure.
- **WPA2 PSK** - Connect to a network that is secured by WPA2. This option requires an encryption key with 8 to 63 characters. This is the default and recommended option.

### Encryption Key

The scanner network is encrypted with a WPA2 key. Enter this key on your remote device, when prompted to establish the connection. If you want to change the encryption key, tap the corresponding button, then enter your own key. The key must consist of 10 to 63 arbitrary digits.

## Proxy Settings

Settings related to connection through a proxy.

- **No Proxy** - Don't use a proxy. Choose this option, if the network that the scanner connects to has direct Internet access.
- **Manual** - Use a manually-configured proxy. Configuration includes:
  - **Host** - The host name (or IP address) of the proxy server.
  - **Port** - The port through which to connect to the proxy server.
  - **Exclusion List** - A comma-separated list of hosts for which no proxy is used.
  - **User Name** - The user name used to log-in to the proxy server (if required).
  - **Password** - The password used to log-in to the proxy server (if required).

### Refresh

Tap to refresh the WLAN settings displayed in this screen.

### Reset

Tap to reset the WLAN settings to their factory default.

If a connection cannot be established, the status immediately turns off after the message *Enabling* is displayed. Check the Network Name and the Encryption Key, when a connection in WLAN mode must be established.

## **Access Point Mode Settings**

The following section describes the additional or special settings for the access point mode.

### **Network Name**

The name of the network that the scanner creates. The scanner serial number is used as the Network Name. Your remote device displays the scanner with this name in the list of the wireless connections. If the scanner is not listed, refresh the network list. After a few seconds the remote device finds the scanner and displays it in the list.

### **Regulatory Domain**

Choose the regulatory domain for the country or region where you are operating the scanner. This ensures that the scanner's access point complies with certain laws and regulations of that country. Note that in some countries it is not possible to change the regulatory domain.

### **WLAN Channel**

Select the WLAN channel that you want to use. Channels 1-13 broadcast at 2.4 GHz, channels 36 and higher broadcast at 5 GHz. The 2.4 GHz channels are slower, but have more range. The 5 GHz channels are faster and are often less crowded, but have less range.

The WLAN channel you select should be a channel that is not used by any other WLAN router nearby or that is least used by other WiFi networks. By using the least busy channel, your WiFi range and transfer rates should improve.

---

**NOTE:** There are phone and PC apps that can help you determine which channels are the busiest. These apps can analyze the other WiFi channels and the signal strength (measured in dBm). This helps you determine if there are channels with strong or weak signals and if the channel you've chosen is set to a busy or even unused channel. This can help you decide which channel should be used.

---

### **Scanner IP Address**

The IP Address of the scanner is set. Use this IP to access the remote user interface.

#### **Update**

Tap to update the displayed settings. This might be necessary, if a connection is lost, because the scanner was out of range, for example.

## **Example Configuration of a Notebook with Microsoft Windows**

### **Connecting the scanner**

1. Click the Wireless Network button on the bottom right of the task bar. A list with the available wireless network connections appears.
2. Select the scanner network in this list. The scanner is listed with the above mentioned network name.

3. Click **Connect**.
4. When prompted, enter the WLAN encryption key.

## **Notebooks in Ad Hoc Mode**

For the WLAN running in ad hoc mode, assign a static IP address to your notebook.

- Open **Control Panel > Network and Internet > Network and Sharing Center**:



Set up a new connection or network

Set up a wireless, broadband, dial-up, ad hoc, or VPN connection; or set up a router or access point.



Set up a wireless ad hoc (computer-to-computer) network

Set up a temporary network for sharing files or an Internet connection.



In the Internet Protocol dialog, choose **Use the following IP address**. Enter a valid IP address and sub-net mask. The IP address and sub-net mask of your notebook must be compatible with the scanner's. Change the last number of the scanner's IP address and use the address. For example, if the scanner has 172.17.16.23, you can enter 172.17.16.100. The sub-net mask must be identical to the scanner's. You may have to disconnect and re-connect to get the connection to work.

## **Open User Interface in the Web Browser**

- With the notebook connected to the scanner, open your web browser.
- In the web browser's address field, enter the scanner's WLAN IP address to access the controller software. For example, <http://172.17.16.23> or <https://172.17.16.23> for a secure connection.
- The **Home** screen of the controller software appears in your web browser, allowing you to control the scanner.

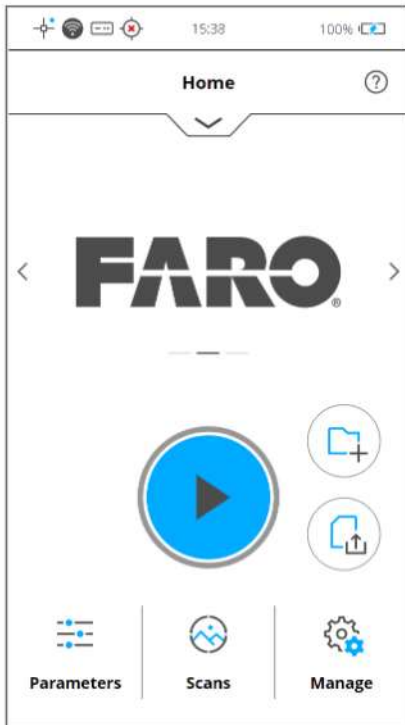



Figure 6-23 Controller software in web browser of a remote device

### **Remotely Accessing Scans on the SSD or SD Card**

To access the scan files that are stored on the scanner's SSD or SD card from a connected remote device, enable remote access in the scanner's controller software.

1. Tap  **Manage** > **General Settings**.
2. Open a file explorer on your remote device, such as Windows Explorer, then enter the **ftp://WLAN\_IP\_ADDRESS\_OF\_SCANNER/Scans** into the address bar. For example, **ftp://172.17.16.23/Scans**.
3. You can download the scans to your remote device via file operations. Note that copying files from the scanner through WLAN can take considerable time. How long this takes depends on the connection speed, signal strength, and scan file size.

## LAN

### **Manage > General Settings > LAN**

With a USB-to-LAN adapter or the optional Automation Adapter, you can connect the scanner to a LAN via an Ethernet socket.

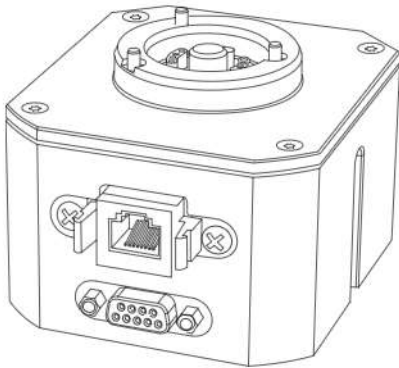


Figure 6-24 Automation Adapter (part number: ACCSS8004)

**IP settings** - Select DHCP to receive an IP address from the network router, or choose **Static** to manually enter an IP address, Gateway, and so on.

**Proxy Settings** - If you need to use a proxy server, select Manual and enter the required information.

## Scanner Details

### **Manage > General Settings > Scanner Details**

**Scanner Name** - Name the scanner.

**Manage Feature Licenses** - Some features of the scanner require special licenses. Activate these features by entering your license key here.

**Owner** - Enter the owner of the scanner.

**Serial Number** - Serial number of the scanner. This number is unique for each scanner. The number can also be also found on the type label on the bottom of the scanner.

**Model** - The scanner type.

**Total No. of Scans** - The total number of scans captured with this scanner.

**Firmware Revision / System Revision** - The revisions of the currently installed firmware and system software.

**Regulatory information** - The FCC and IC ID number of the scanner, and other similar information.

**Implementation Details** - Information about the software licenses of applications and libraries used in the scanner software.

## On-Site Registration

### Manage > On-Site Registration

This page displays the available settings for uploading, processing, and registering scans in a connected SCENE instance.

All uploaded scans are continuously processed and registered according to the settings below.

See the **Processing** and **Registration** chapters in SCENE manual for details regarding the processing and registration-related settings.

**Enable Processing:** This contains settings that define important processing options that can be run remotely on SCENE after the scans have been uploaded.

**Find Spheres:** Detects spheres in the uploaded scans. Use this setting, if you use spheres as external targets for a target-based registration.

**Find Checkerboards:** Detects checkerboards in the uploaded scans. Select this setting, if you use checkerboards as external targets for a target-based registration.

**Find Markers:** Detects markers in the uploaded scans. Select this setting, if you use markers as external targets for a target-based registration.

**Find Planes:** Detects planes in the uploaded scans. This setting can improve a target-based registration.

**Enable Colorization:** Enables the colorization of the uploaded scans.

**Build Scan Point Clouds:** Builds a point cloud from the uploaded scans. Scan point clouds facilitate a fast visualization of scan points.

## Registration

Determine the method used to align and join the uploaded scans to each other in SCENE.

**No Registration:** Select this to skip the registration step.

**Target Based:** Use this to perform a target-based registration for the uploaded scans. The target-based registration uses targets to place the scans. These could be natural or artificial targets, for example, spheres or checkerboards. Enable the corresponding settings in the Enable Processing section for this type of registration.

### Top View Based

Perform a top-view based registration. This method is sufficient in most cases, and does not require additional targets.

**Cloud-to-Cloud:** Perform a cloud-to-cloud registration. This can refine the registration of scans. It can be very time consuming.

**Top View Based plus Cloud-to-Cloud:** Perform a top-view-based registration followed by a cloud-to-cloud registration.



## Network Settings

The IP address and port settings define the network address of the computer running SCENE.

**IP Address:** The IP address of the computer running SCENE is automatically updated.

**Port:** The port number of the computer running SCENE is automatically updated.

## Service

### Manage > Service

**Notifications** - Tap Notifications to see warnings and other status messages. This is not enabled if there are no warnings or errors. Tap an item in the list to view details and possible solutions for the corresponding warning or error. Warnings and errors disappear from the list once they are resolved.

---

**NOTE:** If an empty or full SD card is inserted, the LED turns red and a permanent notification is displayed. Even after the SD card is removed, both warnings remain active until the scanner is shut down.

---

**Internal Mass Storage** - Tap to view information about the total, used, and free capacity of the solid state drive (SSD)

**SD Card** - View details about the currently inserted SD card or format the SD card

---

### **NOTICE: Format the inserted SD card.**

This operation deletes all scans and other data on the SD card. Always use this formatting function for SDXC cards with a capacity of 64 GB or more, because Windows formats such cards with its own file system, which is not supported by the scanner. See [Preparing an SD Card on page 33](#).

---

**Log file** - Export the log file to the SD card in a folder called *Logfile*. Important scanner operations, sensor data, as well as warnings and errors, are saved to the log file to help customer service identify problems and their possible causes.

**Backup** - Backup scan profiles, operators, and scanner parameters to the SD card to help protect from accidental loss if your scanner hardware or storage media fails. You can then archive the data on another storage device, transferring the modified data back to your scanner.

If you own more than one scanner, you can also transfer operators and scan profiles from one scanner to another without manually re-entering the data.

**Backup Name** - Tap to enter the name of the back-up package. Data is saved to the following directory on your SD card: **/Backup/Your\_backup\_name/**.

After specifying the name of the backup folder, select the data to back up, then tap **Backup** to start the operation.

**Restore** - Restore scan profiles, operators, color themes, and scanner parameters from scanner snapshots. See [Service on the previous page](#)

---

**NOTE:** The number behind **Operators** and **Profiles** denotes the number of operators, scan profiles on the scanner.

---

To restore data, it must be saved to an SD card. Create a directory on the SD card called *Backup*, then copy the folder, along with the data to be restored, into this directory.

When finished, insert the SD card with the data to be restored.

List all backup packages on the inserted SD card. Tap the backup package to be restored. A new screen appears.

Select the data from the backup package to be restored, then tap **Restore** to start the restoration process.

---

**CAUTION: The restored data overrides existing data on the scanner.**

For example, if you want to restore or import scan profiles, all existing scan profiles on the scanner are overridden by the new profiles. The scanner's default profiles remain unaffected by this operation. **FARO recommends backing up your data before restoring.**

---

**Firmware update** - Update the scanner with new firmware versions. See [Firmware Update on the next page](#)

**Factory Settings** - Reset the scanner to its factory settings. Use this only in exceptional cases. The scans, scan profiles, scan projects, and operators saved on the scanner are unaffected by this operation.

**Customer Support** - View the FARO Customer Support contact data.

**Command Prompt** - Send commands to the scanner. This function is for FARO Service purposes only.

**Last Service Date** - Date of the last scanner maintenance and certification service.

**Warning ID / Error ID** - The identification number of the warning or error.

**Description** - A detailed description of the warning or error.

**Possible solution** - The notifications consist of an ID followed by a detailed description of the warning or error, as well as a possible solution.

## Firmware Update

⚙️ **Manage** > **Service** > **Firmware Update**



Figure 6-25 Service, Firmware Update

There are two ways to update the firmware of your FARO Focus Premium:

- The scanner is online and can fetch the firmware from a server.
- The firmware is transferred using an SD card.

The update process can take up to 40 minutes, depending on the size of the update. The scanner must be connected to power and have a charged battery to begin the firmware update.

Switch **Fast Installation** on to make installation faster and safer by not updating scanner modules that already have the required version. Disable this option to force updating of all modules. Disabling leads to longer installation times and can increase the risk of unrecoverable failures. We recommend that you keep fast installation enabled.

### **Online Updates**

Enable *Online Updates*. Slide this button to turn it ON or OFF

Select **Set Update Server URL** to set the URL link of the server that provides the online firmware updates.

Tap **Search for Updates Now** to search for firmware updates online.

## Update via SD Card

If you have the firmware update file on your computer, you can use the SD card to transfer it to the scanner. Copy the update file to the folder **Updates** on your SD card. If this folder does not exist, manually create it. Pay attention to lower and uppercase, when entering the folder name. Insert the SD card into the scanner, and tap **Update from SD Card**.

---

**NOTICE: Risk of data loss and non-functional device!**

DO NOT manually shut-down, reset or power-off the scanner during the firmware update process! Any interruption of the firmware update process can result in corruption of the system and making the device inoperable.

---

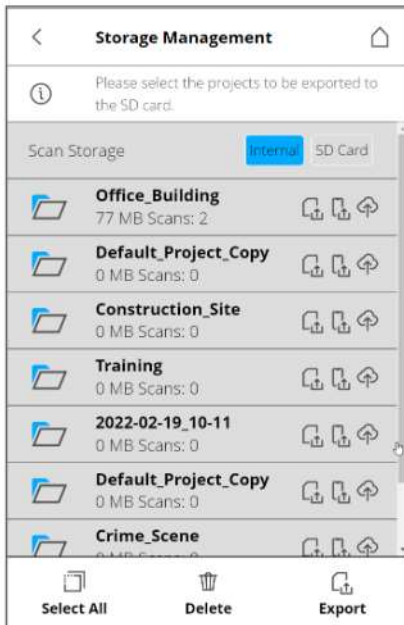
After the update is complete, the scanner might automatically restart, depending on the nature of the updates.

## Storage Management

---

**NOTICE:** All scans in a project must be saved on the same storage media. Do not switch between Internal and SD card storage during a scan project.

---



**Scan Storage** - Choose whether to save the scan data on the internal solid state drive (SSD) or on the removable SD card.

If you select **Internal** scan storage, you can delete scan projects, or can manually export them to the SD card. You can also select **Automatic SD Card Synchronization** which will mirror the selected project or projects SSD to the SD card.

You can also **Delete** or **Export** scan projects from this page.

---

**NOTE:** The icons after each project indicate whether the project has been exported to Stream or Sphere. Any change in the project resets the icon color.

---

## View Scans

View previews of the scans stored on the inserted SD card. A list of all available scans is displayed:



Figure 6-26 Scans List

This list contains all scans available on the SSD or SD card. The list is sorted by the scans' creation dates.

Tap a scan in the list to see its preview picture.

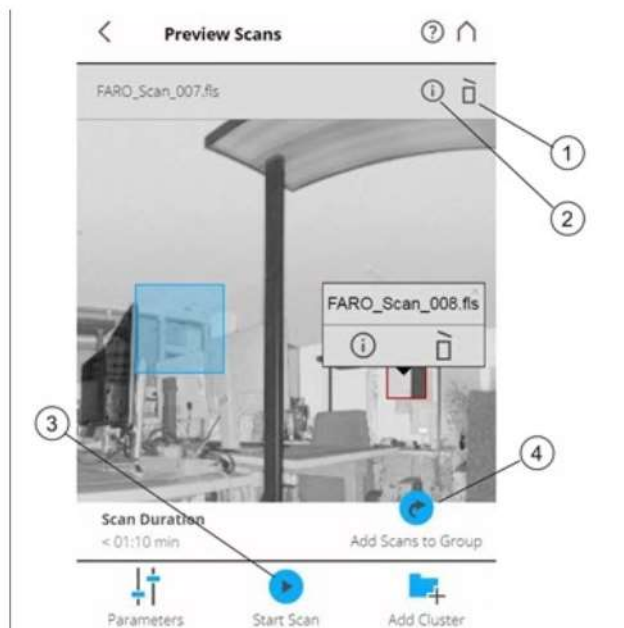



Figure 6-27 Preview of a Scan/Scan Group

- ① **Delete** - Deletes the currently displayed scan from the SD card.
- ② **Info** - Tap to view the scan properties.
- ③ **Start Scan** - Starts a scan, or resumes the previous scan.
- ④ **Add Scans to Group** - Adds a new detail scan to the group.


For scan groups, the detail scans are shown together with the primary scan. Zoom in using a pinching gesture, or the mouse wheel, to enlarge the detail scan's preview. Tap or click the detail scan to display a pop-up window with the name of the detail scan, a link to the related Scan Properties page, and the option to delete the detail scan.

## Online Help and Notifications

### Notifications

Tap **Notifications**  in the navigation bar to receive warnings and other status messages. The button is not enabled, if there are no warnings or errors.

### Help

Open a description of the currently-displayed view by tapping **Help**  in the navigation bar.

The online help provides useful information regarding the currently active view.

## Chapter 7: Special Scanning Modes

The external computer must run SCENE, and be connected to the FARO Focus Premium via WLAN.

By default, SCENE is not configured to offer these modes in the Workflow Bar. To use them, activate the Scanning category in the settings under **Settings > General > User Interface > Show Scanning Category**.

In addition to on-site registration, the Scanning category also offers control of the scanner using SCENE.



Figure 7-1 Scanning toolbar

---

**NOTE:** Although the menu item is visible in SCENE, on-site compensation in SCENE is not compatible with the FARO Focus Premium laser scanner. Use the Stream app for on-site compensation.

---



## Scanner Control

To connect to the scanner:

1. Enter the scanner's IP address.

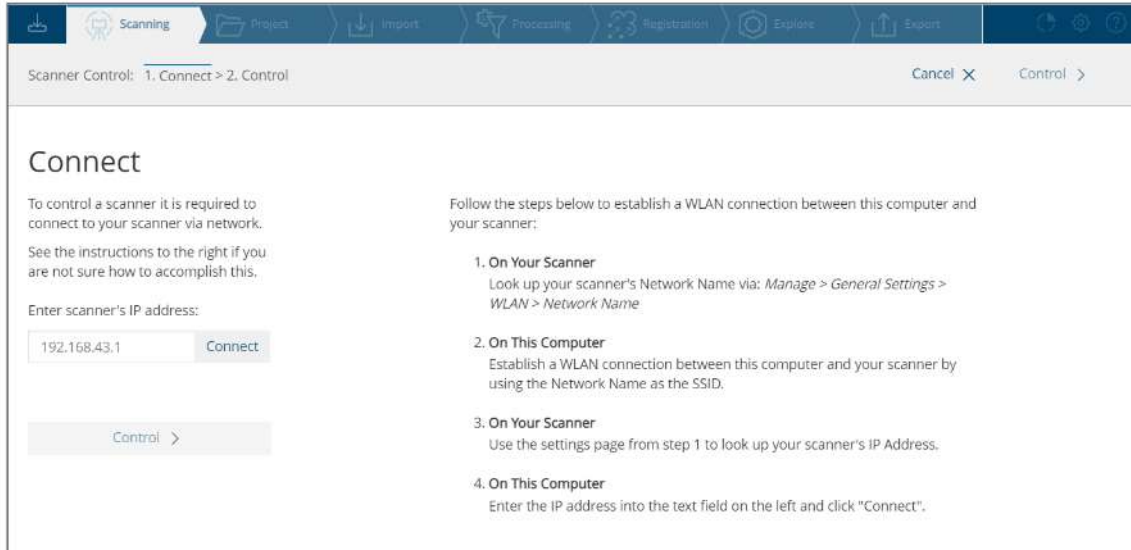


Figure 7-2 Connect page: Enter the IP address

2. Click **Connect** to retrieve the details of the scanner.

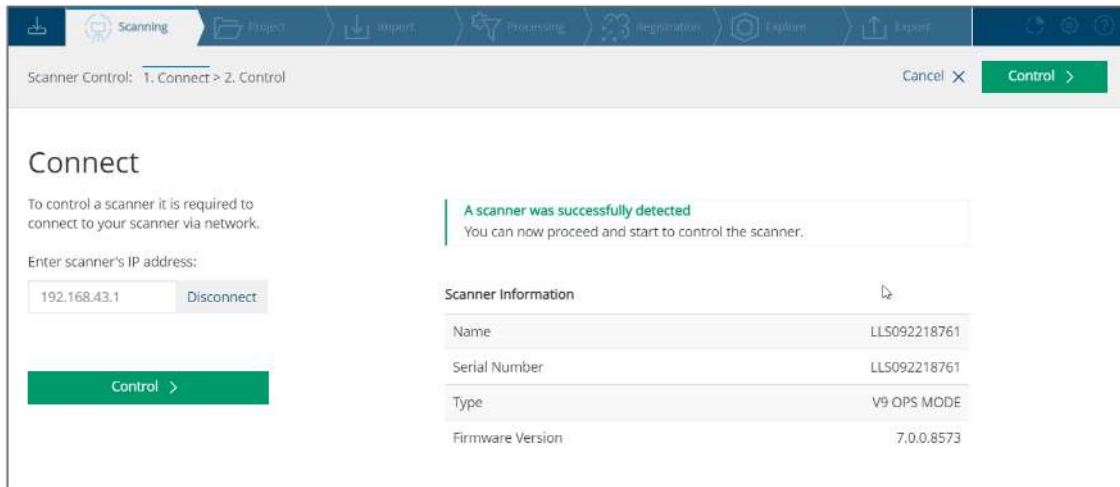


Figure 7-3 Connect to Scanner

If the IP address is not associated with an active laser scanner, an error message is displayed.

3. If a connection to a supported FARO Focus scanner is successful, **Control** becomes active and green. Click to control the scanner through the HTML user interface.

4. SCENE starts the **Scanner Control** task, then displays the scanner user interface. You can control the scanner remotely through this HTML interface.

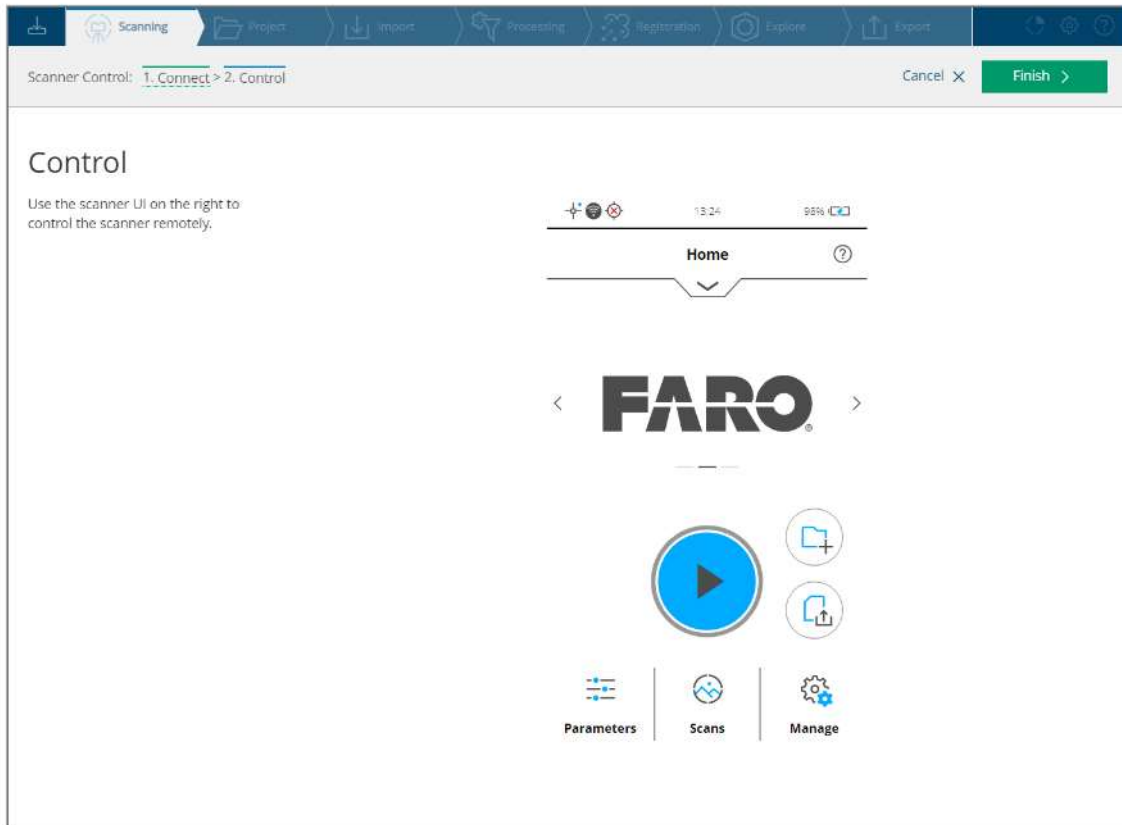


Figure 7-4 Finish or Cancel task

5. Click **Finish** or **Cancel** to close the scanner user interface, scanner control task, and disconnect from the scanner.

## On-Site Registration

---

**NOTE:** This legacy method is not the recommended method for on-site registration. FARO recommends that you use FARO Stream, a phone app that provides a real-time view of the scan and a scan registration feature. See <https://play.google.com/store/apps/details?id=com.faro.flow> to download the app

---

The on-site registration feature enables you to process and register scans while on-site. The scanner must be connected to a computer running SCENE, because processing and registration of the scans are performed in SCENE. Note that on-site registration of the FARO Focus Premium Laser Scanner requires SCENE version 2022, or higher.

After the initial setup, you can perform on-site registration in one of the following ways:

- Directly on the scanner
- Through a connected device, such as a phone or tablet, showing the scanner user interface
- In SCENE

---

**NOTE:** On-site registration is not available on all scanner models. See [Introduction on page 2](#)

---

## On-Site Registration Setup

Use the procedure below to set up on-site registration on the scanner:

### Configure the Scanner

1. Configure the WLAN connection on the laser scanner. See [WLAN on page 89](#).
2. Configure the scan project, scan cluster, scan name, or scan parameters.

Use the procedure below to set up on-site registration on the scanner using your computer:


### Configure Using SCENE

1. Configure the WLAN network of the computer.

---

**NOTE:** The scanner and computer must be continuously connected to the same WLAN network.

---


2. Start SCENE on the computer.
3. Start **On-Site Registration** task under **Scanning** in SCENE.
4. Enter the IP address of the laser scanner. Find the IP address by tapping  **Manage > General Settings > WLAN > IP Address** on the scanner user interface. Enter the IP address exactly as shown.
5. Connect to the FARO Focus Premium.

6. Click the left or right arrow (or swipe), until the home screen changes to **On-Site Registration** scan mode.

---

**NOTE:** The buttons available at the bottom of the screen change; instead of **Scans**, **Map** appears.

---

7. Click  **Manage** > **On-Site Registration** to change on-site registration-specific settings. Consider the following:
  - **Enable Processing** - Enable Processing to find spheres, checkerboards, markers, planes, to enable colorization, or to build the scan point cloud. Disable all scan processing during on-site registration to save time and computing power. The scans can be processed later, off-site.
  - **Registration** - Choose a registration type. The registration settings determine the method used to align the uploaded scans to each other in SCENE. Refer to the SCENE user manual for detailed information regarding different registration methods. Ensure that processing and the relevant marker detection is enabled, when using target-based registration.
  - **Scans to Use for Registration** - Set the number of scans to use for registration. (SCENE first tries to register a new scan using the most recent previous scan. If this registration attempt fails, SCENE tries to register it using the scan immediately before the last scan, and so on. If you make a new scan that has no connection to any previous scan, SCENE attempts to register the new scan with all the scans in the project, one after the other, as previously described. This can be time consuming, if there are a lot of scans in the project. In such cases, consider lowering the number of scans to be used for registration.
  - **IP Address and Port:** - Manually enter the IP address of the computer running the SCENE instance.

---

**NOTE:** These settings are automatically set by SCENE, and should only be changed by experienced users, who have a specific reason to change them.

---

8. On the scanner home page, click **Map**. A map is displayed with the available scans in a project.

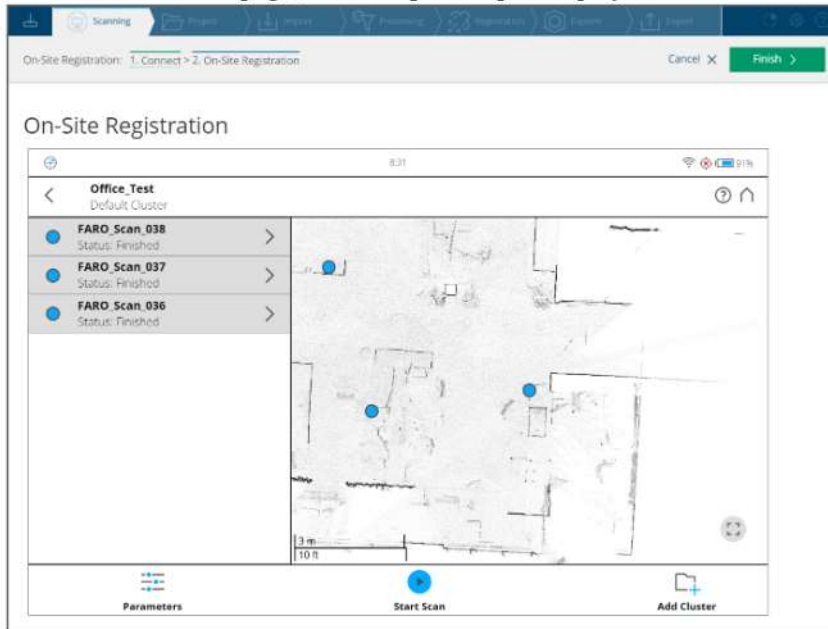


Figure 7-5 On-site registration overview map with list and status of scans

9. Click **Start Scan** to start a new scan on your scanner, or remotely in SCENE. All recorded scans on the current cluster or project opened on the scanner are uploaded to SCENE. The scans are then automatically processed by SCENE.

---

**NOTE:** If one scan fails to register, run a connection scan with the scanner placed between the area of the two different scans. To validate the registration of scans, highlight their points on the map. For more details, refer to [Registration on page 97](#)

---

## Map Page

This shows an overview of the area that has been scanned.



Figure 7-6 Map page

## Overview Map

Display a map of a top-down view of all scans in the current cluster or project that have been successfully registered. Scan positions are shown by blue markers. Click a marker to highlight the points of a scan in the map. A small pop-up menu opens displaying the name of the scan. Tap the scan point on the map to open the **Scan Details** page. Tap the button in the lower right corner of the map to reset the view, so that all markers are visible.

## Status Bar

The status bar is shown below the overview map.

On large screens, the list of scans with their processing status is shown to the left of the map. On small screens, the list can be accessed by clicking the status bar below the map. It displays the most important information. The following messages may appear:

- Number of scans failed: One or more of the following failed: Scanning, processing, scan import, or registration.
- Number of scans in progress.
- Number of scans finished.
- Number of scans unknown: Scans have been initiated on the scanner and their completion status is not known.

Click the status bar to switch to the list page. For details, see [List Page on the next page](#).

## Scan Controls

At the bottom of the screen, three scan controls are available:

- **Parameters** - View the Parameters page.
- **Start Scan** - Start a scan.
- **Cluster** - Switch to project or cluster selection.

## List Page

### **Manage > Projects/Clusters**

This shows a list of all scans in the current cluster or project. On large screens, the list is shown to the left of the map. On small screens, the list can be accessed by clicking the status bar below the map. The on-site registration status of each scan is shown on the left. Tap the right arrow to view the [Scan Details page](#) for the specific scan.

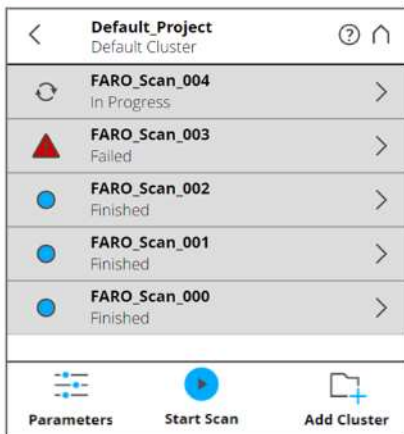






Figure 7-7 List Page

Each list item for a scan contains the following information:

The status indicator displays the scan name and status of the scan as follows:

- Processing:  - The scan is being processed.
- Registration Successful:  - The scan is completed.
- Registration Failed:  - The scan registration failed.

- Waiting for Processing - The scan must be processed.
- Status Unknown  - The scan is initiated, but the status is unknown.

Tap the arrow to the right of the scans to go to the [Scan Details Page](#) below for further actions on the particular scan .

## Scan Details Page

This screen shows detailed information for a single scan.

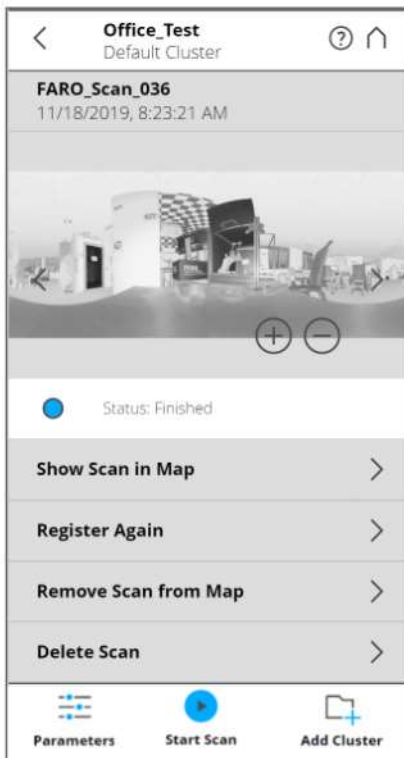


Figure 7-8 Scan Details Page

**Preview image** - The preview image of the scan. As with the preview page, switch current scans by clicking the arrows to the left and right of the preview image.

**Status bar** - Displays the information about the on-site registration status of the scan.

**List of actions** - Lists the different actions that can be performed on the scan, depending on the status of the scan. These are listed below the status bar.

---

**NOTE:** If it is impossible to perform an action, the listed item is grayed out.

---



Possible actions:

**Show Scan in Map** - This option is only available for finished scans. Tap the right arrow to view the map page. The view centers on the selected scan, and it is marked in the map.

**Register** - Again This option is available for scans that either succeeded or failed in registering.

A dialog pops up when you tap the right arrow. Tap **Confirm** to re-register the scan. The scan is being re-registered, and the registration status is displayed as **Unknown** until the process is completed.

**Remove Scan from Map** - This option is available for scans shown in the map that were successfully registered.

A dialog pops up when you tap the right arrow. Use **Confirm** to remove the scan from map. Although the scan is removed from the map, it is not deleted. The scan status is **Registration Failed** after it is removed from the map.

**Delete Scan** - This option is only available for scans that are not **In Progress**.

Tap the right arrow to view the **Delete scan** dialog. Use **Confirm** to delete the scan.

---

**CAUTION:** The scan is deleted from the cluster or project.

---

## On-Site Compensation

On-site compensation (OCS) is a process that tests and improves the angular accuracy of the scanner by measuring and correcting small inconsistencies in how the scanner measures the environment. These inconsistencies are then compensated for in the scanner's software.

### Choose the Compensation Site

Before you begin the OSC process, ensure that the scan site has the following facilities:

- Indoor room without movements (persons, objects or i.e. fan at ceiling etc.) and natural objects well distributed within the room.
- No windows or other reflective planes should be in evidence. This may cause incorrect measurements.
- Walls, floor and ceiling should not have plain walls but structure.
- Lighting conditions are less important because on-site compensation is done with the laser, so video images are not used.
- Download the FARO Stream app from Apple or Google store.

## On-Site Compensation Best Practices

- Use a room without moving objects or the presence of other people.
- Place the scanner in the center of the room and extend the first sections (with biggest diameter) on all 3 legs of the tripod.
- Make sure the tripod is placed on a stable, flat surface. The tripod must not move during scanning.
- Make sure the tripod is fully opened and stable and the center column is not extended.
- Level the scanner (check the inclinometer).
- For best performance of the Focus scanner, perform multiple OSC in different temperature conditions of the scanner. This can be achieved to run multiple OSC starting with a cold scanner (new started scanner) and repeat multiple OSC for about 30 minutes.


OSC detects natural features such as door frames, pictures or other objects from the laser intensity data captured during the scan. It required that the detected natural features are well-distributed within the room.

## Connect Laser Scanner to your Smart Device through Wireless LAN

You must connect your smart device (phone or tablet) with the laser scanner, through WLAN, to remotely access and control the scanner.

## Using the Scanner as a WLAN Access Point

On your scanner:

1. Enable the WLAN on the scanner (see WLAN on page 89).
2. Look up your scanner's network name by tapping  **Manage** > **General Settings** > **WLAN** > **Network Name** on the scanner's user interface.

On your smart device:

Establish a WLAN connection between the phone or tablet, and the scanner, by using the network name as the SSID.

## On-Site Compensation in FARO Stream App

Perform the steps below on your smart device. Connect the scanner in Stream app and swipe the device list entry to the left. Select the OSC icon.



1. Start scanning and compensating by clicking OSC button in Stream app.
2. During the compensation process, the status of progress is displayed. You can cancel the process, if necessary.

When the compensation is finished, the compensation summary is displayed with the results of the compensation.

## Troubleshooting

**Issue:** The process did not identify enough natural targets for compensation.

**Solution:** Select a room with a sufficient amount of natural objects. In case of an insufficient amount of detected natural features, the quality section in Stream app summary will indicate.

**Issue:** No consistent solution could be determined.

**Solution:** Ensure that the tripod and the targets did not move during the procedure.

**Issue:** Communication with the scanner failed.

**Solution:** Ensure that the WLAN connection to the scanner is stable. If this error appears while connecting to the scanner or applying the compensation parameters, repeat the corresponding step.

## Scan Groups

A *scan group* is a set of two or more *detail scans* that were taken using the scan group function. The scanner records fixed spatial relationships between all of the scans in the group. These are shown as a group in SCENE.

## Use Scan Groups to Reduce Scanning Time

To minimize scanning time, select the lowest resolution that will capture the physical details needed for your scan project. This resolution may not scan registration targets with the detail you need for accurate registration. Rather than using a higher resolution for the entire scan, make a 360° lower-resolution scan first as a scan group (referred to here as the *primary scan*), then make several higher-resolution *detail scans* of the targets visible in the first scan. This reduces the total time needed to scan the area, while still yielding high-quality scans of the targets to ensure that registration is accurate.

## About Detail Scans

Detail scans are different from ordinary scans. They contain no high-precision inclinometer and compass data, and are generally useful only in the context of their scan group.

## Creating a Scan Group

---

**NOTICE:** The primary scan and the detail scans must all be taken from the same scanner position. Ensure that the scanner tripod or other mount is immobile throughout the procedure. If possible, use WLAN and operate the scanner from a remote user interface (See [WLAN on page 89](#)). If you must use the touchscreen, do not tap the screen hard enough to disturb the scanner.

---

1. Create a scan. (See [Scanning on page 39](#).) When the scan is finished, the screen switches to the Preview Scans page. This scan is the primary scan of the group.
2. Locate a registration target (or other object) to scan at a higher resolution. Use the mouse wheel (or pinch gestures) to zoom in to the preview image.
3. Click a target to select it. A blue selection rectangle appears. Drag it to adjust the position.



Figure 7-9 Adding detail scans to group

- Click the selection rectangle to open the detail scan pop-up window.

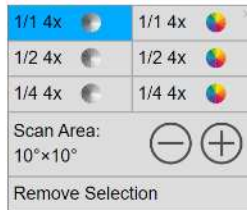


Figure 7-10 Detail scan pop-up

- Select the resolution, quality, and color type for the detail scan. Change the size of the scan area, or remove the selection, if necessary. Click X in the upper-right corner of the window to dismiss it.
- Repeat through for each target to be scanned.
- When you have selected all the targets to be scanned, click **Add Scans to Group**. The scanner begins to make detail scans. The scanner screen shows you the progress.



Figure 7-11 Detail scans completed

When all the detail scans are complete, the preview image of the primary scan is displayed. The positions of the completed detail scans appear as red squares. To make more detail scans, repeat the procedure above. Remember to make all the detail scans needed before moving the scanner or making a new primary scan.



Figure 7-12 Scan group

To see the scan groups on the SD card, return to the scanner's start page and click **Scans**. All scans of a scan group are shown indented below the caption *Scan Group* and the scan group's name (which is always the name of the primary scan).



---

**NOTE:** Scan groups are supported by SCENE 2022 and later. If you import scan groups into an older version of SCENE, the detail scans are treated as normal scans, and are thus likely to have limited use for registration.

---

## Retaking Pictures

When making color scans, photographs are used to colorize the points recorded by the laser. If a person, vehicle, or other object moves into the camera's field of vision after scanning, but while pictures are being taken, it can result in scan points with incorrect colors. If you have set the scanner to allow pictures to be retaken, check the pictures on the scanner immediately after they are taken, select any pictures that include objects that were not part of the laser scan, and retake them.

1. Before scanning, ensure that Retake Pictures is enabled. (⚙️ **Manage** > **General Settings** > **Allow Retaking Pictures**)
2. Begin the scan as usual. When the scan completes, the Color Preview page is displayed.
3. Examine the pictures. If any pictures need to be retaken for any reason, select them by tapping or clicking. If the pictures are fine, close the scan by leaving the Color Preview page.
4. After you have selected all the pictures to be retaken, tap the retake picture button . The scanner retakes and replaces the pictures.
5. If any pictures need to be retaken, repeat the last two steps. Otherwise, close the scan by pressing the finalize scan button .

---

### **NOTICE: Risk of data loss:**

When the Retake Pictures feature is enabled, the scan is not completed until you exit the Color Preview page. Ensure that the scan is closed and that the SD card symbol in the status bar is not blinking before removing the SD card or switching off the scanner.

---

**NOTE:** The scan is not complete until it is closed, and thus no longer visible to other devices, such as while you are retaking pictures. This can affect on-site registration, which begins only after the scan is closed.

---

## Chapter 8: Maintenance

We recommend that you check your FARO Focus Premium at least once a month. This allows you to spot trouble before it starts, and provides you with an efficient measuring system.

The FARO Focus Premium is a precision instrument that contains many sensitive components, and thus must be handled with care. Follow these procedures to prevent problems:

- Check the cables for damage to outside insulation, connectors, and pins.
- Check the housing of the scanner for damage.
- Check the housing and the connectors of the battery for damage.
- Place a dust cover over the scanner, when not in use.
- Do not lubricate the FARO Focus Premium.
- Clean the mirror if it becomes dirty. Refer to the user manual for mirror cleaning instructions

To ensure proper functioning of the scanner, it should be checked by FARO customer service on a regular basis within the yearly maintenance and certification service. The service intervals should not exceed one year. Contact your local FARO Customer Service team for more information.

---

### **WARNING: Hand injuries due to spinning mirror**

If the scanner is accidentally switched on, the mirrors may start to turn. Before starting any cleaning activity:

- shut-down the laser scanner module and remove the battery pack.
- if using an external power supply, remove the power line.

This will prevent the mirror from turning during the cleaning.

---

## Cleaning Instructions for Optics

Major contamination and improper cleaning of optics and lenses can impact the scanning quality. Major damage or wear might require a complete replacement of the part.

---

**NOTICE: Damage or wear of the scanner's mirrors and lenses:** The following must be observed.

To avoid unnecessary damage or wear, clean the optics only if the degree of contamination requires cleaning for proper functioning. For example, if an increase in noise or a decrease of the scan range is observed. Major contamination can impact the scanning quality. In this case, proper cleaning of the outer optics (rotating mirror module or sensor cover glass) is recommended.

Cleaning must be performed only by trained personnel, as self-inflicted damage may result in a complete replacement of the part at the expense of the customer. If in doubt, contact the customer service at FARO (*Technical Support on page 140*).

Do not touch the optical surfaces with your bare hands or laboratory gloves. We recommend using latex gloves. If you have latex allergies, use gloves that are suitable for you or have someone else carry out the cleaning.

Lightly rub the gloves with laboratory cloths after removing them. Use isopropyl alcohol to remove grease and dirt.

Do not touch the mirror with tweezers or forceps.

Use only acetone-free cleaning fluids.

---

## What Is Needed

Gather the supplies listed below, before beginning the procedures detailed in this chapter.

1. **Compressed air, non-flammable spray (oil-free)** such as *Techspray DUSTER 1671* (highly recommended by FARO), available from optical supply stores such as:
  - <https://www.techspray.com/duster-7>
  - <https://www.thorlabs.de/thorproduct.cfm?partnumber=CA4-US>  
(United States and Canada compliant duster with integrated nozzle)
  - <https://www.thorlabs.de/thorproduct.cfm?partnumber=CA4-EU>  
(European Union compliant duster with integrated nozzle)
2. **Acetone-free, non-flammable optics cleaning fluid** such as *Dust-Aid Ultra Clean Liquid* (highly recommended by FARO), available from optical supply stores such as:
  - <https://dust-aid.com/dslr-camera-sensor-cleaning-liquid/>  
(Order via [sales@dust-aid.com](mailto:sales@dust-aid.com))
3. **Lens tissue**, available from optical supply stores such as:
  - <https://www.thorlabs.de/thorproduct.cfm?partnumber=MC-5>



4. **Small dropping bottle and medium wash bottles**, available from optical or chemical supply stores such as:
  - <https://www.thorlabs.de/thorproduct.cfm?partnumber=B2939>
5. **Stainless steel forceps**, available from optical or chemical supply stores such as:
  - <https://www.thorlabs.de/thorproduct.cfm?partnumber=FCP>  
(Forceps, solid stainless steel)
  - <https://www.thorlabs.de/thorproduct.cfm?partnumber=FCPA>  
(Angled Forceps, solid stainless steel)
6. **Powder-free lab gloves** (PVC or silicone), available from optical or chemical supply stores.
7. For strongly contaminated optics, **Mild neutral soap**, available from optical or chemical supply stores.

## Cleaning Slightly Contaminated Optics

---

### **WARNING: Hand injuries due to spinning mirror**

If the scanner is accidentally switched on, the mirrors may start to turn. Before starting any cleaning activity:

- shut-down the laser scanner module and remove the battery pack.
- if using an external power supply, remove the power line.

This will prevent the mirror from turning during the cleaning.

---

## Dry Pre-Cleaning (Non-Contact Cleaning)

Start removal of dust or liquid droplet contamination on mirror or sensor cover by using compressed dry air or special duster sprays (dry cleaning gas).

### **NOTICE: Do not shake the Duster Spray bottle.**

While using the duster spray, ensure that you do not shake the bottle or turn it upside down.

---

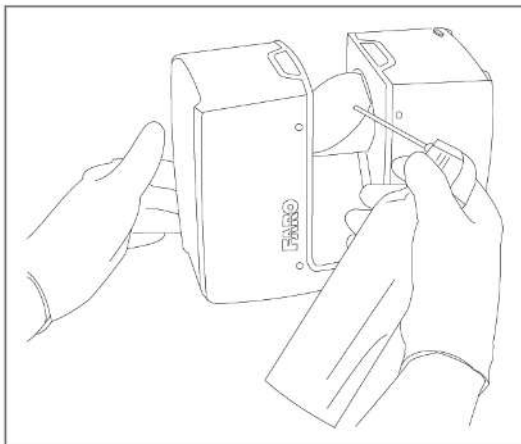


Figure 8-1 Dry pre-cleaning with compressed air or duster cleaning spray

---

**NOTICE: Damage of the scanner's mirrors and lenses**

Avoid touching the optical surface with any objects.

---

1. Gently blow off particles from the optical surface with compressed air.
2. Perform visual inspection.
3. Repeat dry cleaning as required.
4. Proceed with *Wet Cleaning with Tissue and Isopropyl Alcohol as a Cleaning Fluid* below.

## Wet Cleaning with Tissue and Isopropyl Alcohol as a Cleaning Fluid

---

**NOTICE: Damage of the scanner's mirrors and lenses**

Use a new pair of gloves for the following steps.

---

## Prepare the Cleaning Pad

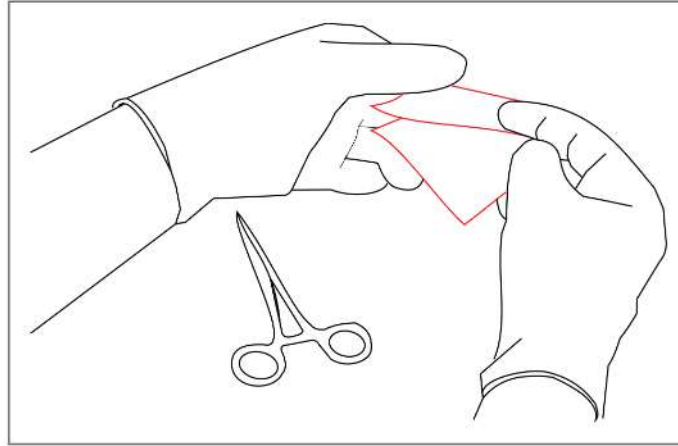


Figure 8-2 Assemble the cleaning pad

1. Combine 2 or 3 sheets of optics cleaning tissue.

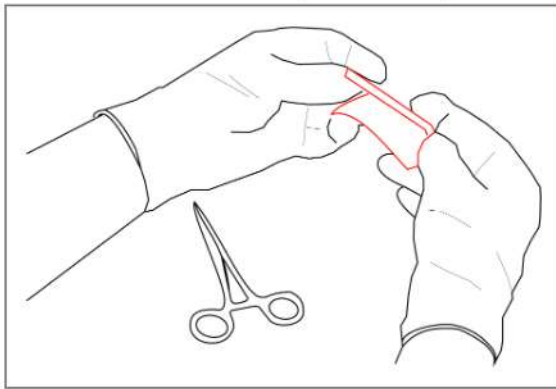


Figure 8-3 Folding the cleaning pad (1)

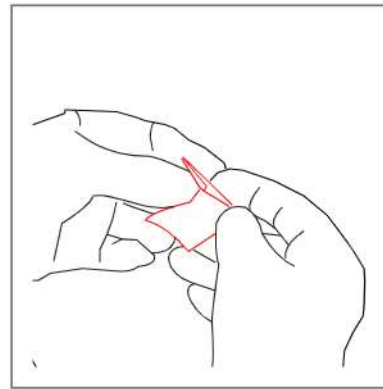
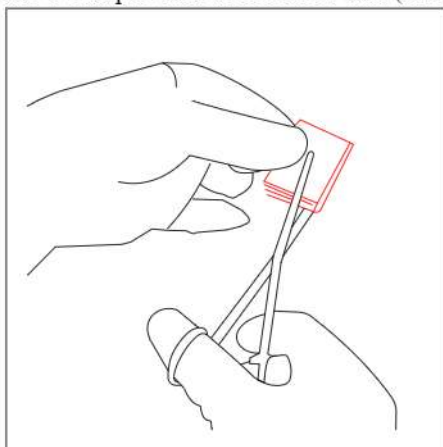


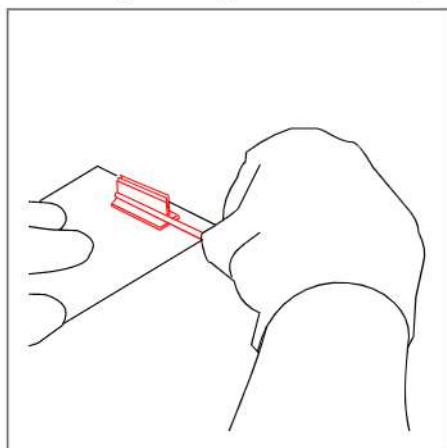
Figure 8-4 Folding the cleaning pad (2)

2. Repeatedly fold the cleaning pads in half, as shown above. Fold twice on the long side, then turn 90° and fold twice more to create a soft pad that is about 30 mm (1.18 in) long.

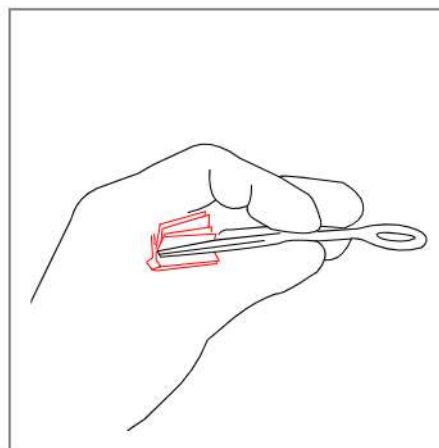


*Figure 8-5 Fix the cleaning pad*

3. Use the forceps to fix the cleaning pad, as shown above. Leave at least 2-3 mm (0.078 in - 0.118 in) between the edge of the pad and the forceps.

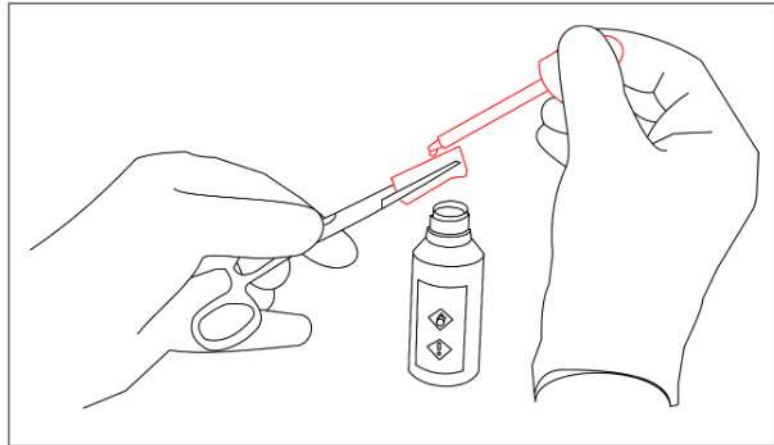


*Figure 8-6 Creating a T-shaped cleaning pad (1)*



*Figure 8-7 Creating a T-shaped cleaning pad (2)*

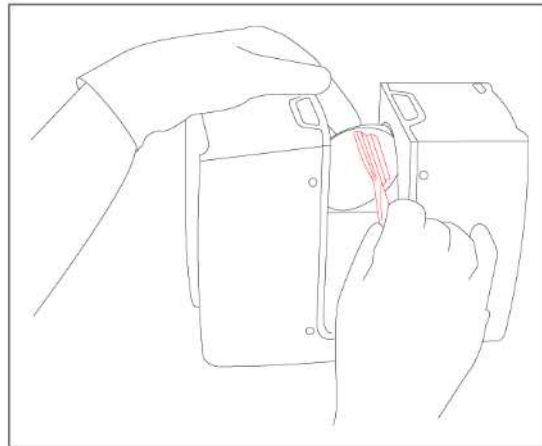
4. Slightly compress the pad on top of the spare cleaning tissues to create a T-shaped cleaning pad, as shown above.



*Figure 8-8 Soaking the cleaning pad*

5. Use the eye-dropper to soak the cleaning pad with isopropyl alcohol or cleaning fluid, as shown above.

## Cleaning mirror module or sensor cover



*Figure 8-9 Cleaning mirror module with pad and isopropyl alcohol or cleaning fluid*

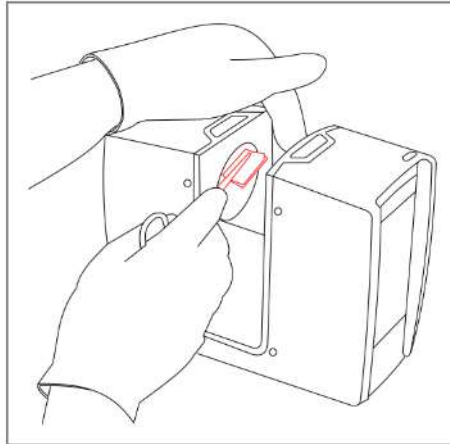


Figure 8-10 Cleaning sensor cover with pad and isopropyl alcohol or cleaning fluid

---

**NOTICE: Damage of the scanner's mirrors and lenses**

Avoid any contamination of the cleaning tissue.

Do not apply pressure while wiping. This might damage the optical surface.

---

1. With a single, consistent linear motion from one end to the other, gently wipe the mirror or sensor cover glass with the cleaning pad, as shown above.
2. After each cleaning cycle, discard the cleaning pad and prepare a new pad as described under [Prepare the Cleaning Pad on page 124](#).
3. Repeat the cleaning until the full mirror or sensor cover aperture has been wiped once.
4. Check cleaning status by visual inspection.
5. Prepare another cleaning pad with isopropyl alcohol or optics cleaning fluid to finalize the procedure.
6. Gently wipe the mirror's entire surface with gentle pressure and in a linear direction once through.
7. Check cleaning status by visual inspection. Ensure that no contamination remains. If there is still contamination, repeat the cleaning with isopropyl alcohol or optics cleaning fluid.

## Cleaning of Strongly Contaminated Optics

---

**WARNING: Hand injuries due to spinning mirror**

If the scanner is accidentally switched on, the mirrors may start to turn. Before starting any cleaning activity:

- shut-down the laser scanner module and remove the battery pack.
- if using an external power supply, remove the power line.

This will prevent the mirror from turning during the cleaning.

---

## Dry Pre-Cleaning (Non-Contact Cleaning)

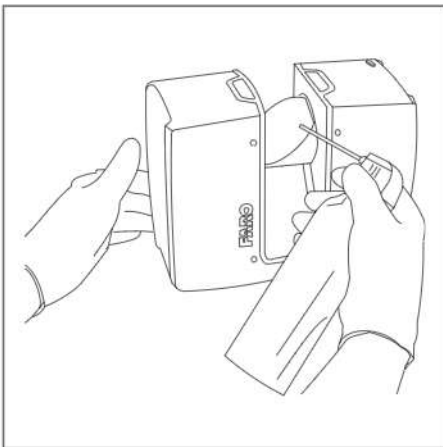
Always start removal of dust or liquid droplet contamination on mirror or sensor cover by using compressed dry air or special duster sprays (dry cleaning gas).

---

**NOTICE: Do not shake the Duster Spray bottle.**

While using the duster spray, ensure that you do not shake the bottle or turn it upside down.

---



*Figure 8-11 Dry pre-cleaning by compressed air or duster cleaning spray*

---

**NOTICE: Damage of the scanner's mirrors and lenses**

Avoid any direct contact with the optical surface.

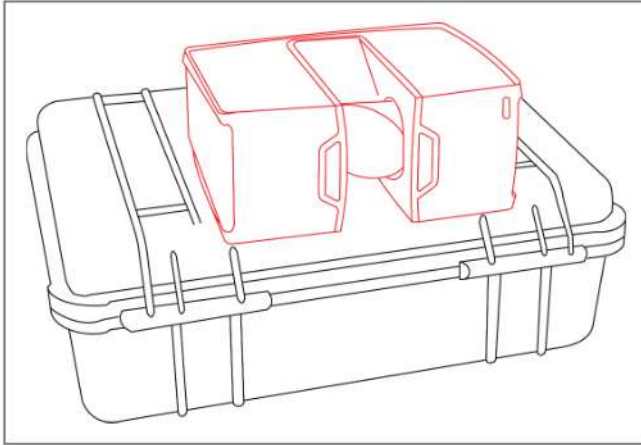
---

1. Gently blow off particles from the optical surface with compressed air.
2. Perform visual inspection.
3. Repeat dry cleaning as required.
4. Proceed with *Wet Cleaning with Water or Diluted Mild Soap Solution* below.

## Wet Cleaning with Water or Diluted Mild Soap Solution

Provide a rigid base, for example, table or transport box topside, as a stable base for the following cleaning procedure:

1. Remove laser scanner unit from its tripod.



*Figure 8-12 Transport box with laser scanner turned and laid on top, with the mirror module facing outwards*

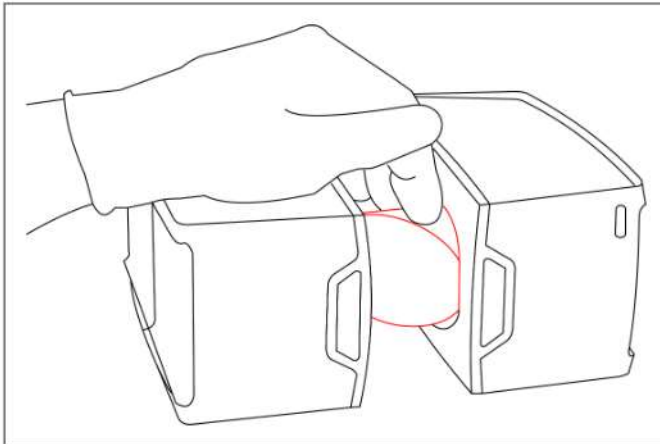
2. Lay the scanner on its long side.
3. Ensure that the mirror can move freely, and is easily accessible for wet cleaning.

---

**NOTICE: Damage of the scanner's mirrors and lenses**

Use dust-free gloves for the following steps.

---



*Figure 8-13 Fix the mirror with your finger tips to keep it in this position*



4. Turn the mirror module into a vertical position, i.e., the mirror points away from scanner. Secure the mirror with your finger tips to keep it in this position.

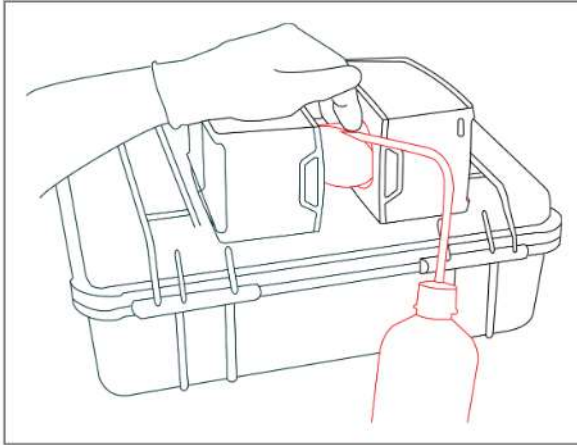


Figure 8-14 Cleaning mirror module or sensor cover

5. Clean the mirror module (that is, the sensor cover) by rinsing with water or diluted neutral soap solution in oscillation motion.

---

**NOTICE: Damage of the scanner's mirrors and lenses**

Wait for the cleaning liquid to drain or dry off. Do not try to dry the optics by wiping with tissue at this stage, because residual contamination may cause severe damage to optics.

---

1. Perform visual inspection of cleaning status.
2. Repeat the rinsing step until contamination is significantly reduced or removed.
3. Wait for the optics to dry.
4. Turn laser scanner into upright (normal) position and ensure stable placement. For example, place scanner on a table or transport box. Alternatively, use tripod for mounting.
5. Proceed with *Wet Cleaning with Tissue and Isopropyl Alcohol as a Cleaning Fluid* on page 123.

## Chapter 9: Technical Data

### General

Power supply voltage	19 V, DC (external supply) 14.4 V, DC (internal battery) Input voltage to power supply: 100/240 V +/- 10%.
Typical Power consumption	19 W (when device is idle) 32 W (while scanning) 72 W (while battery charges)
Typical Battery operation time	About 4 hours
Operating temperature	+5 °C to +40 °C (+41 °F to +104 °F)
Cable connector	Located under the battery cover.
Weight (with battery)	4.4 kg (9.7 lbs)
Size	230 x 283 x 103 mm (9.04 x 11.15 x 5.06 in)
Recommended maintenance / calibration	Annual

### Ports

Accessory bay 1 (red)	Rating voltage: 19 V, DC Power: max. 6.65 W
Accessory bay 2 (black)	Rating voltage: 5 V, DC Power: max. 5 W
USB C port (bottom side). Supports USB 3	Rating voltage: 5 V, DC Power: max. 7.5 W

## Laser (Optical Transmitter)

Laser class	Laser class 1
Wavelength	1553.5 nm
Pulse duration	Approx. 4 ns
Repetition rate	Approx. 125 MHz
Optical power	approx. 800 mW
Beam divergence	Typical 0.3 mrad (0.024°)(1/e)
Beam diameter at exit	Typical 2.12 mm (1/e)

## Data Handling and Control

Data storage	SATA 3.0 SSD 128 GB SDXC V30 64 GB SD Card SD3.0, UHS-I / SDXC / SDHC, max. 512 GB
Scanner control	Touch screen display and WLAN connection. Control by FARO Stream app (iOS & Android) or mobile devices with HTML5.

## Ranging Unit

Distance accuracy:	1 mm (0.039 in)
Angular accuracy	Horizontal: 19 arcsec Vertical: 19 arcsec FARO recommends that you perform on-site compensation if the unit is exposed to extreme temperatures or mechanical stress
Unambiguity interval	614 m for up to 0.5 Mio. pts/s; 307 m at 1 Mio. pts/s;

	153 m at 2 Mio. pts/s
Range:	
White (90% reflectivity)	0.5 – up to 350 m (19.7 in - up to 1148.3 ft)
Dark-grey (10% reflectivity)	0.5 – up to 150 m (19.7 in - up to 492.1 ft)
Black (2% reflectivity)	0.5 – 50 m (19.7 in - up to 164 ft)
Measurement speed (pts/sec)	up to two million
Ranging error*	±1 mm (0.039 in)

\*Ranging error is defined as a systematic measurement error at around 10 m and 25 m.

Ranging noise*	at 10 m (32.8 ft)	at 25 m (82 ft)
White	0.1 mm (0.004 in)	0.2 mm (0.008 in)
Dark-grey	0.3 mm (0.012 in)	0.4 mm (0.015 in)
Black	0.7 mm (0.027 in)	1.2 mm (0.047 in)

\*Ranging noise is defined as the variation of distance samples from repeated measurements of a single point at 122k Pts/sec.

## Color Unit

Resolution:	Up to 166 megapixel color Raw color resolution: 867 megapixel
HDR:	13 megapixel 2x, 3x, 5x brackets
Parallax:	Co-axial design

## Multi-Sensor

Dual axis compensator:	Levels each scan: 19 arcsec; Range ±2°
Height sensor:	Via an electronic barometer the height relative to a fixed point can be detected and added to a scan.
Compass* :	The electronic compass gives the scan an

	orientation.
GNSS:	Integrated GPS & GLONASS

\*Ferromagnetic objects and electromagnetic fields can disturb the earth magnetic field. This, as well as local variations in earth magnetic field (magnetic declination or variation), can lead to inaccurate measurements.

## Interface Connection

WLAN: IEEE 802.11 ac/a/b/g/n 2x2 MIMO, as access point or client in existing networks (2.4 and 5 GHz)

## Deflection Unit

Field of view:	(vertical/horizontal): 300°* / 360°
Step size:	(vertical/horizontal): 0.009° (40,960 3D-Pixel on 360°)
Max. vertical scan speed:	5,820 rpm or 97 Hz

\* 2x150° - Homogeneous point spacing is not guaranteed.

## Ambient Conditions

Ambient Temperature:	+5 °C to +40 °C (+41 °F to +104 °F)
Extended operating temperature of the scanner:	-20 °C to +55 °C (-4 °F to +131 °F) Low temperature operation: the scanner must be powered on while internal temperature is at or above +15 °C (59 °F) High temperature operation*: additional accessory thermal cover required, further information on request.
Storage	-10 °C to +60 °C (+14 °F to +140 °F)
Environment:	Indoor and temporarily outdoor use, pollution degree 2
Humidity:	Non-condensing

Altitude:	< 2000 m (6561 ft)
IP rating of the scanner when in an upright position:	IP54

*\*For extended operation at 55 °C (131 °F): Cool down the accessory thermal cover to -15 °C (5 °F) or colder and store the scanner below 25 °C (77 °F). Prepare scanner with thermal cover and without any other accessory. Turn it on. Scanning is possible for 1 hour. Then turn the scanner off to cool it down to below 25 °C (77 °F) for 2 hours before scanning again with a cooled thermal cover.*

## Scanner Dimensions

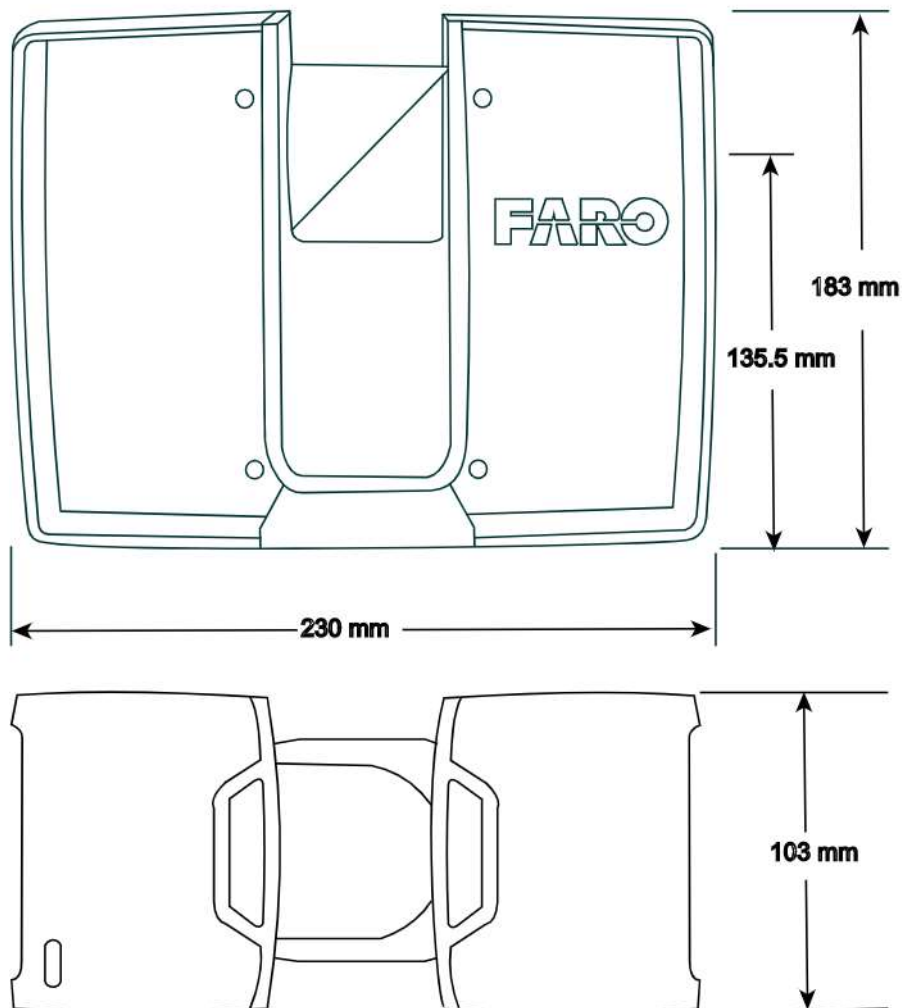


Figure 9-1 Scanner Dimensions

All dimensions are in mm.

## Scanner Mount Dimensions

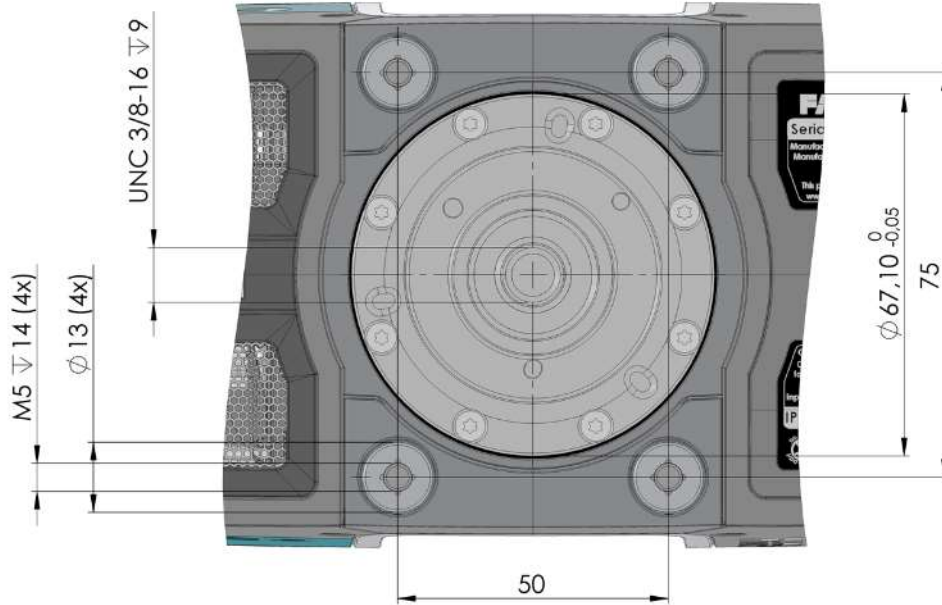


Figure 9-2 Scanner mount

The 3/8 inch central thread can be used to mount a fixation device below the scanner.

The scanner has 4 M5 tapped holes as interface for helical operation.

All dimensions are in mm.

## Chapter 10: Error Messages

<b>Error Message</b>	<b>Description</b>	<b>Action</b>
Internal Error: Invalid parameter	Inconsistent scanner parameters.	Restart scanner. If the problem still occurs, contact FARO Customer Service.
Distance measurement tolerance exceeded	The white reference area on the scanner's base gave inconsistent measurements.	Check cleanliness of this reference area, mirror, and lenses.
error	The device could not be found.	Restart scanner. If the problem still occurs, contact FARO Customer Service.
Color acquisition failure	Color acquisition has unexpectedly stopped. Color acquisition probably incomplete.	Save log file and contact FARO Customer Service.
Out of time failure	Indicates an internal scanner error.	Restart scanner. If the problem still occurs after restart, contact FARO Customer Service.
Module Status Error	Module Status Error: Data version mismatch.	Internal scanner communication problem. Contact FARO Customer Service for a firmware upgrade.
Scanner Operation Failure	Internal scanner error.	Restart scanner. If the problem still occurs, contact FARO Customer Service.
Command not executed	Command could not be executed because of a previous running scan operation. A scan is still active, you cannot start the next operation now.	Wait until scanning is finished.
Scanner temperature too low	Scanner's temperature is too low. Scanning is not possible.	Warm up the scanner before further use.
Temperature too high	Scanner's temperature is too high. Scanning is not possible.	Shut down the scanner and let it cool down, or check if the fan is running.



		If the fan is not running, enable fan cooling under <b>Manage - Sensors - Temperature</b> .
Internal memory full	Internal scanner hard drive is full.	Free up space by deleting wallpapers, operators, projects, or profiles. If that does not help, contact FARO customer service.
Possible file system corruption on SD card detected. Do you want the scanner to repair the file system on the SD card?	The scanner has detected file system corruptions on the inserted SD card. Damages to the file system may occur when you remove the SD card from your computer without using the option <i>Safely Remove Hardware</i> in Microsoft Windows.	Let the scanner repair the SD card. Note that repairing might delete erroneous files from the SD card. If you see this error message again, you should consider replacing the SD card. To prevent damage to the file system when removing the SD card, always use <i>Safely Remove Hardware</i> in Microsoft Windows.
Warning	Permanent warning error.  If an empty or full SD card is inserted, the LED turns red and a permanent notification is displayed. However, when the SD card is removed, both warnings remain active until the scanner is shut down.	Restart scanner. If the problem still occurs, contact FARO Customer Service.
Unknown error	An unknown error occurred.	Restart scanner. If the problem still occurs, contact FARO Customer Service.

## Chapter 11: Disposal

At the end of its life-cycle, this product must not be disposed with normal waste, but instead must be returned to a recycling facility for electric and electronic devices.



Contact your local government or local waste disposal operators to ensure you comply with local laws.

## Chapter 12: Technical Support

FARO Technologies, Inc. is committed to providing the best technical support to our customers. Our Service Policy is detailed under Industrial Service Policy in this manual. If you have any difficulties using one of our products, follow these steps before contacting our Technical Support Team:

- Be sure to read the relevant sections of the documentation.
- Visit the FARO Customer Care area on the Web at [www.faro.com](http://www.faro.com) to search our technical support database. This is available 24 hours a day 7 days a week.
- Document the problem you are experiencing. Be as specific as you can. The more information you can give us, the easier the issue is to solve.
- If you still cannot resolve your issue, have your device's serial number available before calling.
- Emails or faxes sent outside regular working hours are usually answered before 12:00 noon the next working day. If our staff are on other calls, leave a voice mail. Calls are always returned within 24 hours on business days. Remember to leave a detailed description of your difficulty along with your device's serial number. Do not forget to include your name, fax number, and telephone number with extension, so we can promptly reach you.

Support Hours (Monday through Friday)  
8:00 a.m. to 7:00 p.m. Eastern Standard Time (EST)  
Email: [support@faro.com](mailto:support@faro.com)  
North America  
Phone: +1 800 736 2771, +1 407 333 3182 (Worldwide)  
Mexico: 866-874-1154  
Fax: +1 407-562-5294

Support Hours (Monday through Friday)  
8:00 a.m. to 5:00 p.m. Central European Standard Time (CET)  
Europe  
Email: [support.emea@faro.com](mailto:support.emea@faro.com)  
Phone: +800 3276 7378, +49 7150 9797 400 (Worldwide)  
Fax: +800 3276 1737, +49 7150 9797 9400 (Worldwide)

	Support Hours (Monday through Friday) 8:30 a.m. to 5:30 p.m. Singapore Standard Time (SST)
Asia	Email: supportap@faro.com Phone: +1 800 511 1360, +65 6511 1350 (Worldwide) Fax: +65 6543 0111
	Support Hours (Monday through Friday) 9:00 a.m. to 5:00 p.m. Japan Standard Time (JST)
Japan	Email: supportjapan@faro.com Phone: +81 561 63 1411 (Worldwide) Fax: +81 561 63 1412
	Support Hours (Monday through Friday) 8:30 a.m. to 5:30 p.m. China Standard Time (CST)
China	Email: supportchina@faro.com Phone: +400.677.6826 Fax: +86 21 6494 8670
	Support Hours (Monday through Friday) 9:30 a.m. to 5:30 p.m. India Standard Time (IST)
India	Email: supportindia@faro.com Phone: 1800.1028456 Fax: +91 11.4646.5660

## Appendix A: Software License Agreement

This Software License Agreement is part of the Operating Manual for the product and software system for which you have purchased from FARO Technologies Inc. (collectively, the "Licensor"). With your use of the software, you are agreeing to the terms and conditions of this Software License Agreement.

Throughout this Software License Agreement, the term "Licensee" means the owner of the System.

**I.** The Licensor hereby grants the Licensee the non-exclusive right to use the computer software described in this Operating Manual (the "software"). The Licensee shall have no right to sell, assign, sub-license, rent or lease the software to any third party without the Licensor's prior written consent.

**II.** The Licensor further grants the Licensee the right to make a backup copy of the software media. The Licensee agrees that it will not decompile, disassemble, reverse engineer, copy, transfer, or otherwise use the software except as permitted by this section. The Licensee further agrees not to copy any written materials accompanying the software.

**III.** The Licensee is licensed to use the Software only in the manner described in the Operating Manual. Use of the Software in a manner other than that described in the Operating Manual or use of the software in conjunction with any non-Licensor product which decompiles or recompiles the software or in any other way modifies the structure, sequence or function of the software code, is not an authorized use, and further, such use voids the Licensor's set forth below.

**IV.** The only warranty with respect to the software and the accompanying written materials is the warranty, if any, set forth in the Quotation/Purchase Order and [Purchase Conditions on page 144](#) pursuant to which the software was purchased from the Licensor.

**V.** THIS WARRANTY IS IN LIEU OF OTHER WARRANTIES, EXPRESS OR IMPLIED, INCLUDING, BUT NOT LIMITED TO, THE IMPLIED WARRANTIES OF MERCHANTABILITY AND FITNESS FOR A PARTICULAR PURPOSE WITH RESPECT TO THE SOFTWARE AND WRITTEN MATERIALS. IN NO EVENT WILL THE LICENSOR BE LIABLE FOR DAMAGES, INCLUDING ANY LOST PROFITS OR OTHER INCIDENTAL OR CONSEQUENTIAL DAMAGES ARISING OUT OF THE USE OR INABILITY TO USE THE SOFTWARE, NOTWITHSTANDING THAT THE LICENSOR HAVE BEEN ADVISED OF THE POSSIBILITY OF SUCH DAMAGES, THE LICENSOR WILL NOT BE LIABLE FOR ANY SUCH CLAIM BY ANY OTHER PARTY.

**VI.** In the event of any breach by the Licensee of this Agreement, the license granted hereby shall immediately terminate and the Licensee shall return the software media and all written materials, together with any copy of such media or materials, and the Licensee shall keep no copies of such items.

**VII.** The interpretation of this Agreement shall be governed by the following provisions:

**A.** This Agreement shall be construed pursuant to and governed by the substantive laws of the State of Florida (and any provision of Florida law shall not apply if the law of a state or jurisdiction other than Florida would otherwise apply).

**B.** If any provision of this Agreement is determined by a court of competent jurisdiction to be void and non-enforceable, such determination shall not affect any other provision of this Agreement, and

the remaining provisions of this Agreement shall remain in full force and effect. If any provision or term of this Agreement is susceptible to two or more constructions or interpretations, one or more of which would render the provision or term void or non-enforceable, the parties agree that a construction or interpretation which renders the term of provision valid shall be favored.

C. This Agreement constitutes the entire Agreement, and supersedes all prior agreements and understandings, oral and written, among the parties to this Agreement with respect to the subject matter hereof.

**VIII.** If a party engages the services of an attorney or any other third party or in any way initiates legal action to enforce its rights under this Agreement, the prevailing party shall be entitled to recover all reasonable costs and expenses (including reasonable attorney's fees before trial and in appellate proceedings).

## Appendix B: Purchase Conditions

All Purchase Orders (hereafter, the "Order") for FARO-provided products and services (hereafter, the "Product") are subject to the following terms and conditions, which are agreed to by the Purchaser. All capitalized terms are defined in Section [8.00 Definitions on page 148](#) hereafter.

### 1.00 Payment of Purchase Price

1.01 Purchaser hereby promises to pay to the order of FARO all deferred portions of the Purchase Price, together with interest on late purchase price payments payable at 1.5% per month (18% per annum).

1.02 The Purchaser grants to FARO a security interest in the products sold pursuant to the Order, which may be perfected by UCC-1 Financing Statements to be recorded in the applicable County of the Purchaser's business location and filed with the Secretary of State's Office, which security interest will remain in effect until payment in full of the purchase price together with interest on late purchase price payments payable thereon had been received by FARO.

1.03 If the Purchaser fails to make full payment of the purchase price within the period set out in the Order, FARO shall at its option have the following remedies, which shall be cumulative and not alternative:

- a) the right to cancel the Order and enter the Purchaser's premises to re-take possession of the Product, in which event the Purchaser agrees that any down-payment or deposit shall be forfeited to FARO, as liquidated damages and not as a penalty, and all costs incurred by FARO in connection with the removal and subsequent transportation of the Product shall be payable by the Purchaser upon written demand;
- b) the right to enter the Purchaser's premises and remove any Software, components of the Product or other items necessary in order to render the Product inoperative;
- c) the right to withhold all services which would otherwise be required to be provided by FARO pursuant to the Warranties set out in Section [4.00 Warranties and Limitation of Liability on the next page](#) hereof;
- d) terminate any existing software license agreement and
- e) pursue any other available remedy, including suing to collect any remaining balance of the purchase price (i.e., accelerate the payment of the purchase price causing the entire balance to immediately become due and payable in full).
- f) Customer will be charged a 20% restocking fee for refusal to accept equipment as delivered. Equipment must be returned unopened within 10 business days of receipt at customer facility.

1.04 If Purchaser fails to make payment(s) in accordance with the terms of this Order, the Purchaser's Products may be rendered inoperable until such payment terms are met.

No waiver by FARO of its rights under these conditions shall be deemed to constitute a waiver of subsequent breaches or defaults by the Purchaser. In the event more than one Product is being purchased pursuant to the Order, unless otherwise set forth herein, each payment received by FARO from Purchaser shall be applied pro rata against the cost of each product rather than being applied to the purchase price of any product.

## **2.00 Delivery and Transportation**

2.01 Delivery dates are estimates and not guarantees, and are based upon conditions at the time such estimate is given.

2.02 FARO shall not be liable for any loss or damage, whether direct, indirect or consequential, resulting from late delivery of the Product. The Purchaser's sole remedy, if the Product is not delivered within 90 days of the estimated delivery date, shall be to cancel the Order and to recover from FARO without interest or penalty, the amount of the down-payment or deposit and any other part of the purchase price which has been paid by the Purchaser. Notwithstanding the foregoing, such right of cancellation shall not extend to situations where late delivery is occasioned by causes beyond FARO's control, including, without limitation, compliance with any rules, regulations, orders or instructions of any federal, state, county, municipal or other government or any department or agency thereof, force majeure, acts or omissions of the Purchaser, acts of civil or military authorities, embargoes, war or insurrection, labor interruption through strike or walkout, transportation delays and other inability resulting from causes beyond FARO's control to obtain necessary labor, manufacturing facilities or materials from its usual sources. Any delays resulting from such causes shall extend estimated delivery dates by the length of such delay.

2.03 Responsibility for all costs and risks in any way connected with the storage, transportation, and installation of the Product shall be borne entirely by the Purchaser. If any disagreement arises as to whether or not damage to the Product was in fact caused in storage, transit or on installation, the opinion of FARO's technical advisors, acting reasonably, shall be conclusive.

## **3.00 Installation and Operator Training**

3.01 The Purchaser shall be responsible for installation of the Product, including, without limitation, the preparation of its premises, the uncrating of the Product and setting up of the Product for operation. Purchaser may elect to order contract services from FARO to perform this service should they elect to do so.

## **4.00 Warranties and Limitation of Liability**

4.01 FARO warrants that (subject to Section 4.06), the Product shall be free from defects in workmanship or material affecting the fitness of the Product for its usual purpose under normal conditions of use, service, and maintenance. A complete statement of FARO's maintenance/warranty service is set forth in [Purchase Conditions on the previous page](#).

4.02 FARO warrants that the Software shall operate according to specifications and the System shall operate and perform in the manner contemplated in connection with the usual purpose for which it is designed.

4.03 The maintenance/warranty set out in paragraphs 4.01 shall expire at the end of the twelve (12) month period commencing on the date of shipment from the FARO factory (the "Maintenance/Warranty Period").

4.04 Subject to the limitations contained in Section 4.06, the Warranties shall apply to any defects found by the Purchaser in the operation of the FARO Focus Premium and reported to FARO within the



Maintenance/Warranty Period. If the FARO Focus Premium or the Software is found by FARO, acting reasonably, to be defective, and if the defect is acknowledged by FARO to be the result of FARO's faulty material or workmanship, the FARO Focus Premium will be repaired or adjusted to the extent found by FARO to be necessary or at the option of FARO, replaced with a new FARO Focus Premium or parts thereof at no cost to the Purchaser.

4.05 Claims under the Warranties shall be made by delivering written notice to FARO of the defect in the System, the FARO Focus Premium. Within a reasonable time of receipt of such notice, FARO shall have the System and FARO Focus Premium diagnosed by its service personnel, and maintenance/warranty service will be provided at no cost to the Purchaser if the System and FARO Focus Premium is found by FARO to be defective within the meaning of this Section.

(If, in the reasonable opinion of FARO after diagnosis of the system and the FARO Focus Premium are not defective, the Purchaser shall pay the cost of service, which shall be the amount that FARO would otherwise charge for an evaluation under a non-warranty service evaluation.

4.06 The Warranties do not apply to:

- a) Any defects in any component of a System where, if in the reasonable opinion of FARO, the FARO Focus Premium, Software or System has been improperly stored, installed, operated, or maintained, or if Purchaser has permitted unauthorized modifications, additions, adjustments, and/or repair to any hard drive structure or content, or any other part of the System, or which might affect the System, or defects caused or repairs required as a result of causes external to FARO workmanship or the materials used by FARO. As used herein, "unauthorized" means that which has not been approved and permitted by FARO.
- b) The Warranties shall not cover replacement of expendable items, including, but not limited to, fuses, diskettes, printer paper, printer ink, printing heads, disk cleaning materials, or similar items.
- c) The Warranties shall not cover minor preventive and corrective maintenance, including, but not limited to, replacement of fuses, disk drive head cleaning, fan filter cleaning and system clock battery replacement.
- d) Any equipment or its components which was sold or transferred to any party other than the original Purchaser without the expressed written consent of FARO.

4.07 Factory Repairs

- a) IF SYSTEM IS UNDER MAINTANENCE/WARRANTY: The Purchaser agrees to ship the Product to FARO in the original packing containers. FARO will return the repaired or replacement Product. FARO will incur the expense of the needed part and all return shipping charges to the Purchaser. FARO may authorize the manufacturer of a component of the Product to perform the service.
- b) IF SYSTEM IS UNDER PREMIUM SERVICE PLAN: When practical and subject to availability, FARO will make available to the Purchaser substitute component parts or FARO Focus Premium's ("Temporary Replacements") while corresponding parts of the Purchaser's system or FARO Focus Premium are undergoing repair at FARO's factory. Shipping charges for these "Temporary Replacement" parts or FARO Focus Premium's will be the responsibility of FARO.
- c) IF SYSTEM IS NOT UNDER MAINTANENCE/WARRANTY: The Purchaser is responsible for the cost of the replacement part or software, and all shipping charges. All charges shall be estimated and prepaid prior to commencement of repairs.
- d) Replacement parts used for repair may be new, refurbished, or contain refurbished materials.

4.08 Nothing herein contained shall be construed as obligating FARO to make service, parts, or repairs for any product available after the expiration of the Maintenance/Warranty Period.

#### 4.09 Limitation of Liability

FARO shall not be responsible under any circumstances for special, incidental or consequential damages, including, but not limited to, injury to or death of any operator or other person, damage or loss resulting from inability to use the System, increased operating costs, loss of production, loss of anticipated profits, damage to property, or other special, incidental or consequential damages of any nature arising from any cause whatsoever whether based in contract, tort (including negligence), or any other theory of law. FARO's only liability hereunder, arising from any cause whatsoever, whether based in contract, tort (including negligence) or any other theory of law, consists of the obligation to repair or replace defective components in the System or FARO Focus Premium subject to the limitations set out above in this section.

This disclaimer of liability for consequential damage extends to any such special, incidental or consequential damages which may be suffered by third parties, either caused directly or indirectly resulting from test results or data produced by the system or any component thereof and the Purchaser agrees to indemnify and save FARO harmless from any such claims made by third parties.

4.10 The foregoing shall be FARO's sole and exclusive liability and the Purchaser's sole and exclusive remedy with respect to the system.

THE SOLE RESPONSIBILITY OF FARO UNDER THE WARRANTIES IS STATED HEREIN AND FARO SHALL NOT BE LIABLE FOR CONSEQUENTIAL, INDIRECT, OR INCIDENTAL DAMAGES, WHETHER THE CLAIM IS FOR BREACH OF WARRANTY, NEGLIGENCE, OR OTHERWISE.

OTHER THAN THE EXPRESS WARRANTIES HEREIN STATED, FARO DISCLAIMS ALL WARRANTIES INCLUDING IMPLIED WARRANTIES OF MERCHANTABILITY AND FITNESS.

4.11 FARO does not authorize any person (whether natural or corporate) to assume for FARO any liability in connection with or with respect to the Products. No agent or employee of FARO has any authority to make any representation or promise on behalf of FARO, except as expressly set forth herein, or to modify the terms or limitations of the Warranties. Verbal statements are not binding upon FARO.

4.12 The Maintenance/Warranties extend only to the Purchaser and are transferable, only under the following conditions:

- The FARO Focus Premium is currently under maintenance/warranty.
- New owner is, or becomes, a certified user.
- A FARO maintenance/warranty transfer form is completed, and submitted to Customer Service.

All claims under the Warranties must originate with the Purchaser, or any subsequent owner, and the Purchaser will indemnify and save FARO harmless from any claims for breach of warranty asserted against FARO by any third party.

4.13 Oral representations of FARO or its sales representatives, officers, employees or agents cannot be relied upon as correctly stating the representations of FARO in connection with the system. Refer to this purchase order, any exhibits hereto and any written materials supplied by FARO for correct representations.

4.14 PURCHASER ACKNOWLEDGES THAT IT HAS PURCHASED THE SYSTEM BASED UPON ITS OWN KNOWLEDGE OF THE USES TO WHICH THE SYSTEM WILL BE PUT. FARO SPECIFICALLY DISCLAIMS ANY WARRANTY OR LIABILITY RELATED TO THE FITNESS OF THE SYSTEM FOR ANY PARTICULAR PURPOSE OR ARISING FROM THE INABILITY OF THE PURCHASER TO USE THE SYSTEM FOR ANY PARTICULAR PURPOSE.

#### **5.00 Design Changes**

5.01 The FARO Focus Premium, the Software and the System are subject to changes in design, manufacture, and programming between the date of order and the actual delivery date. FARO reserves the right to implement such changes without the Purchaser's consent, however, nothing contained herein shall be construed as obligating FARO to include such changes in the FARO Focus Premium, Software or System provided to the Purchaser.

#### **6.00 Non-Disclosure**

6.01 All Software including, without limitation, the Operating System Program and any FARO special user programs, provided to the Purchaser as part of the system, either at the time of or subsequent to the delivery of the FARO Focus Premium, is the intellectual property of FARO. The Purchaser shall not reproduce or duplicate, disassemble, decompile, reverse engineer, sell, transfer or assign, in any manner the Software or permit access to or use thereof by any third party. The Purchaser shall forthwith execute any further assurances in the form of non-disclosure or licensing agreements which may reasonably be required by FARO in connection with the software.

#### **7.00 Entire Agreement / Governing Law / Miscellaneous / Guarantee**

7.01 These Purchase conditions constitute the entire agreement between FARO and the Purchaser in respect to the Product. There are no representations or warranties by FARO, express or implied, except for those herein contained and these conditions supersede and replace any prior agreements between FARO and the Purchaser.

7.02 No representative of FARO has any authority to modify, alter, delete or add to any of the terms or conditions hereof. Any such modifications shall be absolutely void unless made by instrument in writing properly executed by an actual authorized employee or agent of FARO.

7.03 The terms and conditions hereof shall be binding upon FARO and the Purchaser, and shall be construed in accordance with the laws of the State of Florida, United States of America.

7.04 FARO shall be entitled to recover all of its reasonable fees and costs including, but not limited to, its reasonable attorney's fees incurred by FARO in connection with any dispute or litigation arising thereunder or in connection herewith, including appeals and bankruptcy or creditor reorganization proceeds.

7.05 These conditions shall not be construed more strictly against one party than another as a result of one party having drafted said instrument.

#### **8.00 Definitions**

8.01 "FARO" means FARO Technologies Inc.

8.02 "Purchaser" means the party buying the Product and who is legally obligated hereunder.

8.03 "Software" means all computer programs, disk drive directory organization and content, including the computer media containing such computer programs and disk drive directory organization and content, sold pursuant to the Order.

8.04 "Product" means the FARO Focus Premium, the Software, operating manuals and any other product or merchandise sold pursuant to the Order. If the Purchaser is buying only a FARO Focus Premium, or the Software, Product will mean the product being purchased by the Purchaser pursuant to the Order.

8.05 "System" means a combination of the FARO Focus Premium, the Software, the Computer, and optional parts and accessories associated with the FARO Focus Premium.

8.06 "Purchase Order" means the original document issued from the Purchaser to FARO, listing all parts and/or services to be purchased and the agreed purchase price.

8.07 "Maintenance/Warranty Transfer Form" means a document to be completed for the transfer of the FARO Maintenance/Warranty. This document is available from FARO upon request.

## Appendix C: Industrial Service Policy

This Service Plan (hereafter, the "Plan") is part of the Operating Manual for the FARO manufactured product purchased from FARO Technologies Inc. (hereafter, "FARO"). The Plan and all of the optional additions, are subject to the conditions in Appendices A, B, & C, and are subject to change. This appendix refers to FARO's service plans as written in the sales advertising literature, and is meant to provide additional details that the literature does not permit.

1.00 The purchase of the Plan shall occur with the purchase of the FARO products.

1.01 The plan shall apply to systems exclusively created or authored by FARO.

1.02 The plan shall include FARO product hardware only, and can not be extended or transferred through the sale of any part of the system to a third party unless the entire system has been sold or transferred.

1.03 The plan shall not cover Hardware or Software which has been subjected to misuse or intentional damage. FARO reserves the right to determine the condition of all returned Hardware and/or Software.

1.04 FARO shall determine the service method and contractor to service/repair all hardware which is not directly manufactured by FARO. All outside contractor terms and conditions are available from FARO and are incorporated herein by reference.

1.05 FARO shall not be responsible for any non-FARO authored software which inhibits the operation of the system. Furthermore the plan will not cover the re-installation of any software.

1.06 The Hardware and Software are subject to changes in design, manufacture, and programming. All updates are as follows:

a) Hardware - The Scanner and all of the associated optional parts, and the Computer are not subject to updates.

b) Software - All computer programs, authored by FARO, which are used in conjunction with the FARO provided Hardware, will be updated (maintenance upgrades) for the life of the Purchaser's current version. All enhancement and functionality upgrades must be purchased.

c) 3rd Party Software - All computer programs not authored by FARO will not be updated under the Plan. The purchaser is responsible for the acquisition of all 3rd party software updates and warranty service or claims.

1.07 In the event that FARO replaces any product or replacement product, FARO retains all right, title, and interest in and to all products or portions of products that were replaced by FARO.

2.00 Definitions

2.01 "FARO" means FARO Technologies Inc.

2.02 "Purchaser" means the party buying the Product and who is legally obligated hereunder.

2.03 "Software" means all computer programs, disk drive directory organization and content, including the diskettes containing such computer programs and disk drive directory organization and content, sold pursuant to the Order.

2.04 "Product" means the Scanner, the Software, operating manuals and any other product or merchandise sold pursuant to the Order. If the Purchaser is buying only a scanner, or the Software, Product will mean the product being purchased by the Purchaser pursuant to the Order.

2.05 "System" means a combination of the Hardware, the Software, the Computer, and optional parts associated with the FARO Focus Premium .

2.06 "Hardware" means the scanner and all of the associated optional parts, and the Computer if provided by FARO.

2.07 "Software" means all computer programs, authored by FARO, which are used in conjunction with the FARO provided Hardware.

## Service Plans

Information about FARO's service plan options can be found on the FARO Knowledge Base  
[https://knowledge.faro.com/Essentials/General/Service\\_Plans\\_for\\_FARO\\_Hardware](https://knowledge.faro.com/Essentials/General/Service_Plans_for_FARO_Hardware).

## Appendix D: Industrial Products Service Policy

A one-year maintenance/warranty comes with the purchase of new FARO manufactured hardware products.

The most regular of the FARO Standard Maintenance Terms and Conditions can be found in the FARO Knowledge base.

### FARO Software

All FARO Software users will receive maintenance releases until the end of life for the version at no charge electronically or at a minimal fee for the computer media package. All enhancement and functionality upgrades will be available for purchase upon release.

### Hardware & Software Training

FARO's training program is designed to instruct trainees in the operation of FARO's hardware and software, which the customer has purchased. The training classes are set up for each trainee to obtain valuable hands on application exposure. This will help the trainees in their everyday use of the hardware and software. FARO also feels that once the trainee completes the training, finding solutions to problems or applying applications will be simpler.



## Appendix E: Certifications

### Certifications

#### CE Declaration of Conformity

Hereby, FARO Technologies, Inc. declares that the radio equipment type FARO Focus Premium is in compliance with Directive 2014/53/EU.

The full text of the EU declaration of conformity is available at the following Internet address:

<https://www.faro.com/en/Support-Overview/Technical-Documentation/Certificates>

FARO Technologies, Inc. is represented in Europe by FARO Europe GmbH, Komtal-Münchingen, Germany.


Frequency	Power
2402 ~ 2480 MHz	11 dBm
2412 ~ 2472 MHz	20 dBm
5150 ~ 5350 MHz	23 dBm
5470 ~ 5725 MHz	23 dBm
13.56 MHz	-2 dBuA/m

SW version: 7.0.0.6861

#### RF exposure statement

The minimum distance between the user or any bystander and the radiating structure of the transmitter is 20 cm (7.87 in).

5150 ~ 5350 MHz is limited to indoor use in these countries:

	BE	BG	CZ	DK	DE	EE	IE	EL	ES	FR	HR
	IT	CY	LV	LT	LU	HU	MT	NL	AT	PL	PT
	RO	SI	SK	FI	SE	UK(NI)	LI	IS	NO	TR	CH

## FCC Notices

### FCC Equipment Authorization

Trade name: FARO

Product Name: Focus Premium

#### **This device complies with Part 15 of the FCC Rules**

Operation is subject to the following conditions:

1. The devices may not cause harmful interference, and
2. The devices must accept any interference received, including interference that may cause undesired operation.

Contains FCC ID: YQMLLS090

---

**NOTE:** This equipment has been tested and found to comply with the limits for a Class A digital device, pursuant to part 15 of the FCC Rules. These limits are designed to provide reasonable protection against harmful interference when the equipment is operated in a commercial environment. This equipment generates, uses, and can radiate radio frequency energy and, if not installed and used in accordance with the instruction manual, may cause harmful interference to radio communications. Operation of this equipment in a residential area is not likely to cause harmful interference.

---

### Industry Canada (IC):

This device complies with Industry Canada license-exempt RSS standard(s). Operation is subject to the following two conditions:

- (1) This device may not cause interference.
- (2) This device must accept any interference, including interference that may cause undesired operation of the device.

Le présent appareil est conforme aux CNR d'Industrie Canada applicables aux appareils radio exempts de licence. L'exploitation est autorisée aux deux conditions suivantes:

- (1) l'appareil ne doit pas produire de brouillage, et

(2) l'utilisateur de l'appareil doit accepter tout brouillage radioélectrique subi, même si le brouillage est susceptible d'en compromettre le fonctionnement.

Contains IC ID: 9265A-LLS090

## Radio Equipment Certification Under the Radio Act of Japan

当該機器には電波法に基づく、技術基準適合証明等を受けた特定無線設備を装着している



® 003-160104

〒 D160055003

**FARO Technologies, Inc.**

250 Technology Park  
Lake Mary, FL 32746  
800-736-2771 U.S. / +1 407-333-3182 Worldwide  
Email: support@faro.com

**FARO Brazil**

Rua San José, 360  
Cotia, SP 06715-862  
Phone: 0800-047-4271 / +55 11 3500-4600  
Email: suporte@faro.com

**FARO Europe GmbH**

Lingwiesenstrasse 11/2 D-70825  
Komtal-Münchingen, Germany  
FREECALL +800 3276 73 78 / +49 7150/9797-400  
FREEFAX +800 3276 1737 / +49 7150/9797-9400  
Email: support.emea@faro.com

**FARO Singapore Pte. Ltd.**

No. 03 Changi South Street 2  
#01-01 Xilin Districentre Building B  
SINGAPORE 486548  
TEL: +65 6511.1350  
Email: supportap@faro.com

**FARO Japan,c.**

716 Kumada, Nagakute-City,  
Aichi, 480-1144, Japan  
Tel: 0120-922-927, 0561-63-1411  
FAX:0561-63-1412  
Email: supportjapan@faro.com

**FARO (Shanghai) Co., Ltd.**

1/F, Building No. 2,  
Jux Information Technology Park  
188 Pingfu Road, Xuhui District  
Shanghai 200231, China  
Tel.: 400.677.6826  
Email: supportchina@faro.com

**FARO Business Technologies India Pvt. Ltd.**

E-12, B-1 Extension,  
Mohan Cooperative Industria Estate,  
New Delhi-110044, India  
Tel.: 1800.1028456  
Email: supportindia@faro.com